

Whirlpool

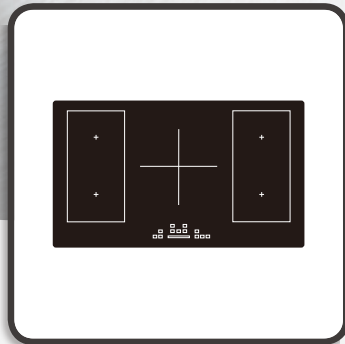

**Health & Safety, Use & Care, Installation Guide and
Online Warranty Registration Information**

Model: IWHH9050CC



www.whirlpool.com.au
www.whirlpool.co.nz



INDUCTION COOKTOP USE AND CARE GUIDE

Dear User,

Thank you for choosing our products. We are sure you will find your new appliance a pleasure to use. Before you use the appliance, we recommend that you read through these instructions carefully and retain for future reference. Design and specification may change due to product development, no prior notice will be given.

Table of Contents

IMPORTANT SAFETY INSTRUCTIONS	3
INSTALLATIONS	6
OPERATION INSTRUCTIONS	11
Booster	15
Flexicook	15
Child Lock	16
Stop & Go	17
Timer	18
Detection of Pan and Small Articles	20
Residual Heat Warning	20
Auto Shutdown	20
Over-heat Protection	20
Over-flow Protection	21
Cooking Guidelines	21
Cooking Table	22
Cleaning and Maintenance	23
Troubleshooting	25
Technical Specifications	25
After-sales service	27

IMPORTANT SAFETY INSTRUCTIONS

SAFETY INSTRUCTIONS IMPORTANT TO BE READ AND OBSERVED

Download the complete instruction manual on Whirlpool official website or call the phone number shown on the official website.

Before using the appliance, read these safety instructions. Keep them nearby for future reference. These instructions and the appliance itself provide important safety warnings, to be observed at all times. The manufacturer declines any liability for failure to observe these safety instructions, for inappropriate use of the appliance or incorrect setting of controls.

 **WARNING:** If the cooktop surface is cracked, do not use the appliance - risk of electric shock.

 **WARNING:** Danger of fire: Do not store items on the cooking surfaces.

 **CAUTION:** The cooking process has to be supervised. A short cooking process has to be supervised continuously.

 **WARNING:** Unattended cooking on a cooktop with fat or oil can be dangerous - risk of fire. Never try to extinguish a fire with water: instead, switch off the appliance and then cover flame e.g. with a lid or a fire blanket.

 Do not use cooktop as a work surface or support. Keep clothes or other flammable materials away from the appliance, until all the components have cooled down completely - risk of fire.

 Metallic objects such as knives, forks, spoons and lids should not be placed on the cooktop surface since they can get hot.

 Very young children (0-3 years) should be kept away from the appliance. Young children (3-8 years) should be kept away from the appliance unless continuously supervised. Children from 8 years old and above and persons with reduced physical, sensory or mental capabilities or lack of experience and knowledge can use this appliance only if they are supervised or have been given instructions on safe use and understand the hazards involved. Children must not play with the appliance. Cleaning and user maintenance must not be carried out by children without supervision.

⚠ After use, switch off the cooktop element by its control and do not rely on the pan detector.

⚠ **WARNING:** The appliance and its accessible parts become hot during use. Care should be taken to avoid touching heating elements. Children less than 8 years of age shall be kept away unless continuously supervised.

PERMITTED USE

⚠ **CAUTION:** the appliance is not intended to be operated by means of an external switching device, such as a timer, or separate remote controlled system.

⚠ This appliance is intended to be used in household and similar applications such as: staff kitchen areas in shops, offices and other working environments; farm houses; by clients in hotels, motels, bed & breakfast and other residential environments.

⚠ No other use is permitted (e.g. heating rooms).

⚠ This appliance is not for professional use. Do not use the appliance outdoors.

INSTALLATION

⚠ The appliance must be handled and installed by two or more persons - risk of injury. Use protective gloves to unpack and install - risk of cuts.

⚠ Installation, including water supply (if any), electrical connections and repairs must be carried out by a qualified technician. Do not repair or replace any part of the appliance unless specifically stated in the user manual. Keep children away from the installation site. After unpacking the appliance, make sure that it has not been damaged during transport. In the event of problems, contact the dealer or your nearest After-sales Service. Once installed, packaging waste (plastic, styrofoam parts etc.) must be stored out of reach of children - risk of suffocation. The appliance must be disconnected from the power supply before any installation operation - risk of electric shock. During installation, make sure the appliance does not damage the power cable - risk of fire or electric shock. Only activate the appliance when the installation has been completed.

⚠ Carry out all cabinet cutting operations before fitting the appliance and remove all wood chips and sawdust.

⚠ If the appliance is not installed above an oven, a separator panel (not included) must be installed in the compartment under the appliance.

ELECTRICAL WARNINGS

⚠ It must be possible to disconnect the appliance from the power supply by unplugging it if plug is accessible, or by a multi-pole switch installed upstream of the socket in accordance with the wiring rules and the appliance must be earthed in conformity with national electrical safety standards.

⚠ Do not use extension leads, multiple sockets or adapters. The electrical components must not be accessible to the user after installation. Do not use the appliance when you are wet or barefoot. Do not operate this appliance if it has a damaged power cable or plug, if it is not working properly, or if it has been damaged or dropped.

⚠ If the supply cord is damaged, it must be replaced with an identical one by the manufacturer, its service agent or similarly qualified persons in order to avoid a hazard - risk of electric shock.

CLEANING AND MAINTENANCE

⚠ **WARNING:** Ensure that the appliance is switched off and disconnected from the power supply before performing any maintenance operation; never use steam cleaning equipment - risk of electric shock.

⚠ Do not use abrasive or corrosive products, chlorine-based cleaners or pan scourers.

ENERGY SAVING TIPS

Make the most of your hot plate's residual heat by switching it off a few minutes before you finish cooking. The base of your pot or pan should cover the hot plate completely; a container that is smaller than the hot plate will cause energy to be wasted.

Cover your pots and pans with tight-fitting lids while cooking and use as little water as possible. Cooking with the lid off will greatly increase energy consumption.

Use only flat-bottomed pots and pans.

NOTE

People with a pacemaker or similar medical device should use care when standing near this induction cooktop while it is on. The electromagnetic field may affect the pacemaker or similar device. Consult your doctor, or the manufacturer of the pacemaker or similar medical device for additional information about its effects with electromagnetic fields of the induction cooktop.

INSTALLATIONS

The appliance must be installed and connected in accordance with current regulations.

After unpacking the appliance, ensure there is no visible damage. If it has been damaged during transit, DO NOT USE, contact the "seller/ dealer/ Whirlpool After-Sales Service" immediately.

Selection of installation equipment

- Cut out the work surface according to the sizes shown in the drawing.
- For the purpose of installation and use, a minimum of 5 cm space shall be preserved around the hole.
- Be sure the thickness of the work surface is at least 30mm. Please select heat-resistant work surface material to avoid larger deformation caused by the heat radiation from the hotplate.

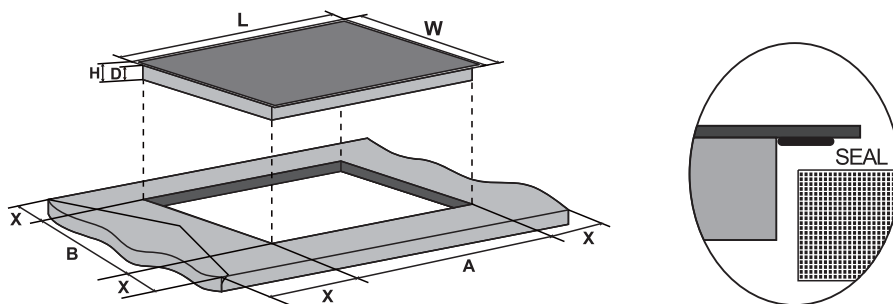

Model	L (mm)	W (mm)	H (mm)	D (mm)	A (mm)	B (mm)	X-min (mm)
IWHH9050CC	900	520	60	52	880	500	50

Under any circumstances, make sure the induction cooktop is well ventilated and the air inlet and outlet are not blocked. Ensure the induction cooktop is in good work state. As shown below:

! **Note:** The safety distance between the cooking zones and the cupboard above the cooking zones should be at least 760mm.

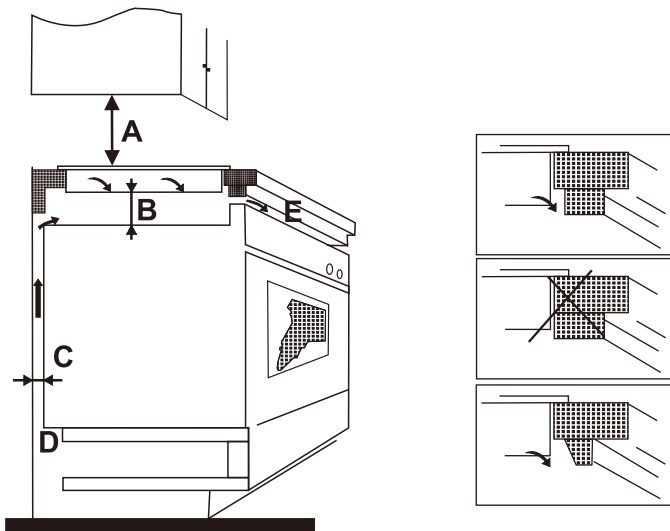

A (mm)	B (mm)	C (mm)	D (mm)	E (mm)
760 minimal	50 minimal	20 minimal	Air intake 20 minimal	Air exit 5 minimal

Installing the foam gasket

Before inserting the cooktop into the opening in the kitchen worktop, the supplied foam gasket (in a plastic bag) must be attached to the lower side of the ceramic glass.

Do not install the cooktop without the foam gasket!

The gasket should be attached to the cooktop in the following method:

- Remove the protective film from the gasket.
- Then attach the gasket to the lower side of the glass, next to the edge.
- The gasket must be attached along the entire length of the glass edge and should not overlap at the corners.
- When installing the gasket, make sure that the glass does not come into contact with any sharp objects.

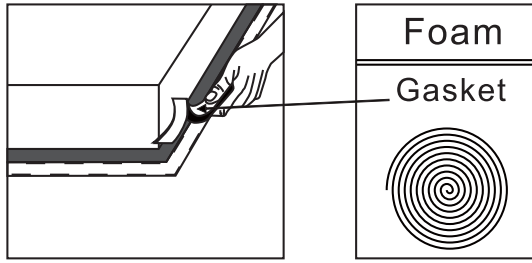

Fix clips to cooktop

The unit should be placed on a stable, smooth surface (use the packaging). Do not apply force onto the controls protruding from the cooktop.

There is one easy fit kit package for each cooktop, including fixing clips and screws (total 2pcs of clips and 2pcs of screws).

Insert the fixing clips into the fixing holes on the 2 sides of housing. Fix the clip to the housing with the screw, after which insert the cooktop to the cabinet/work surface.

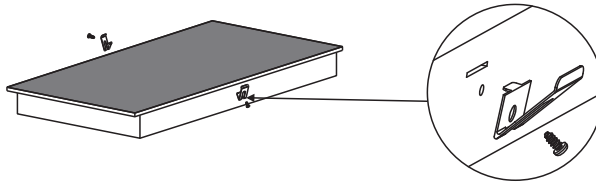

Fix cooktop to cabinet

Insert the cooktop into the cabinet/work surface as below diagrams and the mounted clips on the sides can secure your cooktop sturdily.

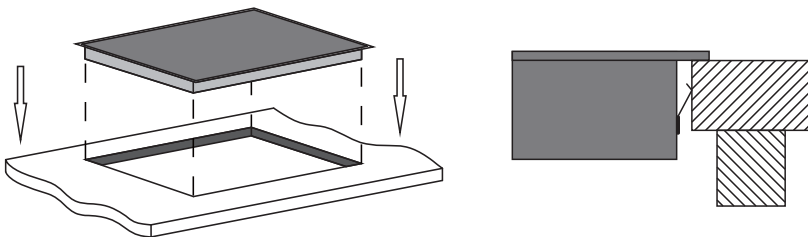

Connecting the cooktop to the mains power supply

The power supply should be connected in compliance with the relevant standard, or a single-pole circuit breaker. The appliance has a large power rating and must be connected to electricity by a Qualified Electrician.

Notes:

1. If the cable is damaged or needs replacement, this should be done by an after-sales technician using the proper tools, so as to avoid any accidents.
2. If the appliance is being connected directly to the mains supply, an omni polar circuit breaker must be installed with a minimum gap of 3mm between the contacts.
3. The installer must ensure that the correct electrical connection has been made and that it complies with safety regulations.
4. The cable must not be bent or compressed.
5. The cable must be checked regularly and only replaced by qualified technician.

Cautions

1. The cooktop must be installed by qualified personnel or technicians. Please never conduct the operation by yourself.
2. The induction cooktop shall not be mounted to cooling equipment, dishwashers and rotary dryers.
3. The induction cooktop shall be installed such that better heat radiation can be ensured to enhance its reliability.
4. The wall and induced heating zone above the work surface shall withstand heat.
5. To avoid any damage, the sandwich layer and adhesive must be heat resistant.
6. A steam cleaner is not to be used.

For those model power cord without plug, the method of connections shown below.

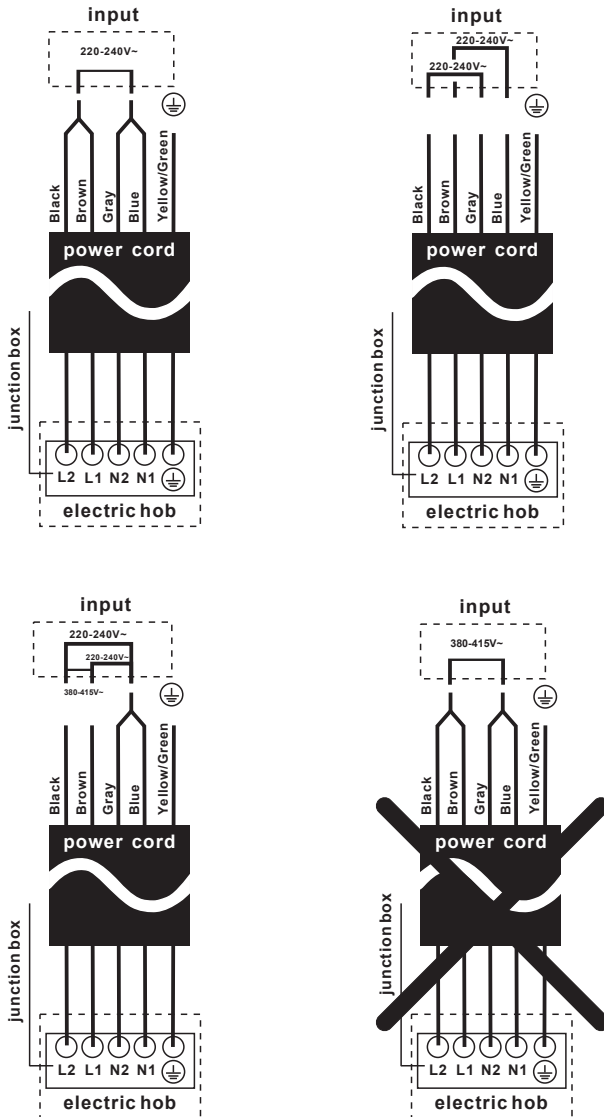

OPERATION INSTRUCTIONS

Model: IWHH9050CC

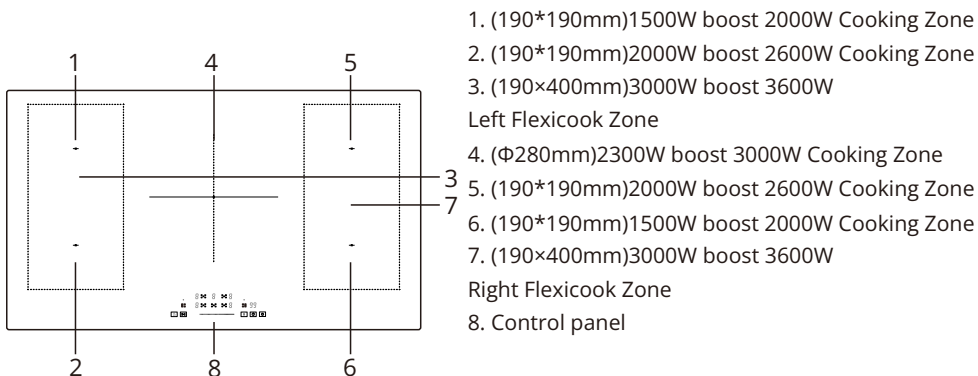

Control Panel

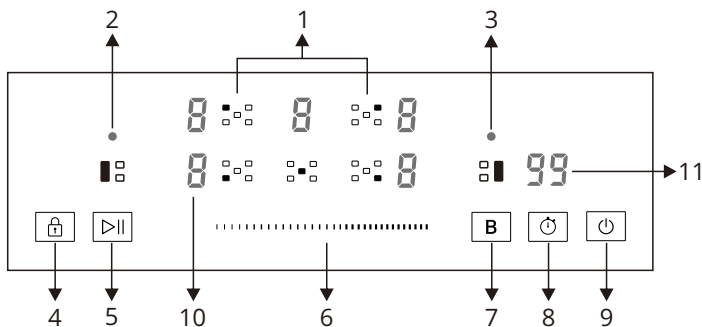

1. Cooking Zone selection button
- 2/3. Left/Right Flexicook zone control button
4. Child Lock control button
5. Stop & Go control button
6. Scroll keypad
7. Booster function control button
8. Timer control button
9. ON/OFF button
10. Cooking level indicator
11. Timer indicator

Notes: Product diagrams in the manual for reference only, there might be slightly difference due to continually product improvements.

BEFORE USING YOUR NEW COOKTOP

- Read this guide, taking special note of the 'Safety Warnings' section.
- Remove any protective film that may still be on your new induction cooktop.

USING THE TOUCH CONTROLS

- The controls respond to touch, so you don't need to apply any pressure.
- Use the ball of your finger, not its tip.
- You will hear a beep each time a touch is registered.
- Make sure the controls are always clean, dry, and that there is no object (e.g. a utensil or a cloth) covering them. Even a thin film of water may make the controls difficult to operate.



Move your finger horizontally across the scroll keypad (Slider) to adjust on the power level and timer.

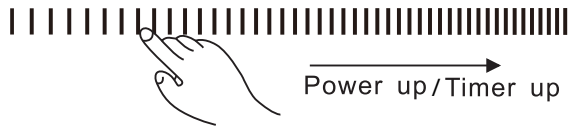

CHOOSE THE RIGHT COOKWARE



• Only use cookware with a base suitable for induction cooking. Look for the induction symbol on the packaging or on the bottom of the pan.

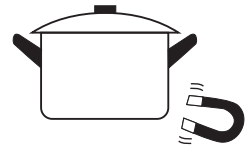

- You can check whether your cookware is suitable by carrying out a magnet test. Move a magnet towards the base of the pan. If it is attracted, the pan is suitable for induction cooktop.
- If you do not have a magnet:
 1. Put some water in the pan you want to check.
 2. If  does not flash in the display and water is heating, the pan is suitable.
- Cookware made from the following materials is not suitable for an induction cooktop: pure stainless steel, aluminum or copper without a magnetic base, glass, wood, porcelain, ceramic, and earthenware.

- Induction cooktop are made from smooth ceramic glass, the heat comes from a magnetic induction coil which heats the cookware but not the cooking surface. The heat from the cookware is transferred to the food.
- It's important that you use only metal pans specifically designed and/or approved for use on induction cooktop. Never allow melamine or plastic containers to come in contact with the heat zones.
- A pan which diameter less than 140mm may not be detected by the induction cooktop.

Do not use cookware with jagged edges or a curved base.



Make sure that the base of your pan is smooth, sits flat against the glass, and is the same size as the cooking zone. If you use a smaller pot, the efficiency could be less than expected. Always centre your pan on the cooking zone.

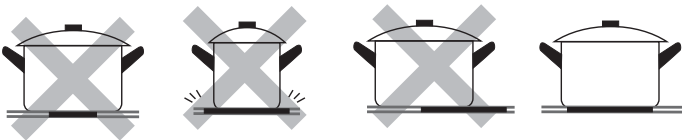

Always lift the pans off the cooktop – do not slide, otherwise they may scratch the glass.

Suggested Cookware Dimensions for Induction Cooktop

The induction cooktop will automatically detect the base of the cookware. Ensure that the size of the cookware base corresponds to the size of the cooking zone. To obtain the best efficiency of your cooktop, place the cookware in the centre of the cooking zone.

Base diameter of the cookware:

Cooking zone	Minimum (mm)	Maximum (mm)
190mm	140	190
280mm	230	280
Flexicook zones	190 x 400	200 x 400

Using your cooktop

To start cooking

1. After the cooktop be connected to electricity and power on. Press and hold the ON/OFF  control button for about 3 seconds till you hear a “beep” to turn the cooktop on. Now the cooktop enters into Standby mode, all cooking level and timer indicators show “-”.

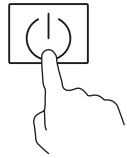

2. Place a suitable pan on the cooking zone you wish to use.

- Make sure the bottom of the pan and the surface of the cooking zone are clean and dry.

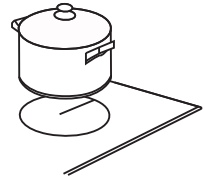

3. Set heating level of cooking zone

Before adjusting the heating level, you need to touch the heating zone selection control button to select and activate the cooking zone you wish to use.

The cooking level indicator of the selected zone flashes when being active, then you could adjust its heat level as below:

- adjust heat setting by sliding the slider control.

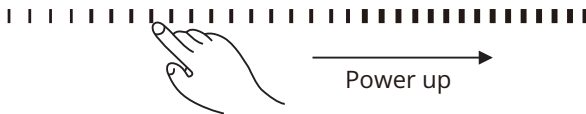
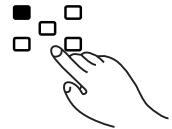

Notes:

1. After connect to electricity, when power on, the buzzer of cooktop beeps once, all indicators light up for 1 second then go out.
2. When the cooktop is in Standby mode, the induction cooktop will auto turn off when there is no action within 1 minute, follow with a beeping sound.
3. To turn on the cooktop, press the ON/OFF button and hold on for about 3 seconds. To turn if off, press the ON/OFF button.
4. The power level can be adjusted from 0 to 9, default setting is at level 5.
5. The cooking level indicator of the selected zone flashes when adjusting. The setting is confirmed when the number flashes for 5 seconds and stops flashing.

To turn off cooktop

1. You can turn the cooking zone off by adjust heat setting to level 0, which indicator shows“-”.
2. You can also turn the whole cooktop off by touching the ON/OFF  control button.

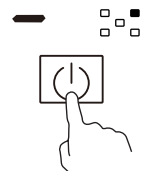

Note: If there is power cut off during cooking, all setting will be cancelled.

Note: The cooling fan of induction cooktop will remain on for about 1 minute after the cooktop be turned off.

BOOSTER

You can use the “Booster” function to boost power of relevant cooking zone for a maximum power rating for 5 minutes. This function could reduce the cooking time, which is convenient for cooking when in a hurry.

To activate the booster function

1. Turn on the cooking zone you want to use with the booster function .
Select the cooking zone you would like to activate the booster with the heating zone selection control button.

2. Touch the Booster function control button , the cooking level indicator will show “b” and flash for 5 seconds. The Booster function is activated.

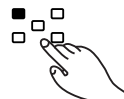

Note:

1. When both cooking zones in the same vertical direction are working at the same time, the booster function can be activated for one of the zones while the other zone will automatically be lowered to level 2 should its power is higher than level 2.

2. After booster finish, the cooking zone will return to original setting.

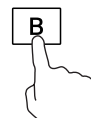

To cancel the booster function

1. Ensure the cooking zone with the activated Booster function is selected. Touch the Booster function control button to cancel.

2. Otherwise, adjust the power level with the scroll keypad for the selected cooking zone.

FLEXICOOK

The Flexicook areas can be used as two independent zones or combine into a single zone, accordingly to your cooking needs.

Flexicook areas are each made of two independent inductors that can be controlled separately. When working as a single zone, a cookware is moved from one zone to the other one within the Flexicook areas keeping the same power level of the zone

where the cookware originally was placed, and the part that is not covered by cookware is automatically switched off. Ideal for cooking with oval or rectangular pots or with pan supports.

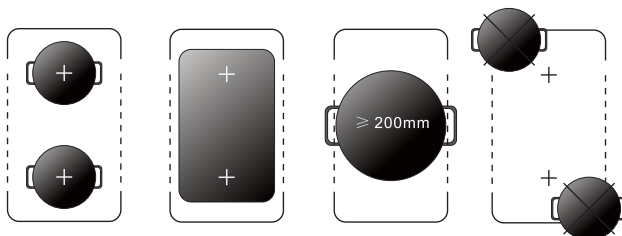

Important: Make sure to place the cookwares centered on the single cooking zone. In case of big pot, oval, rectangular and elongated pans make sure to place the pans centered on the cooking zone covering both cross.



To activate the Flexicook areas

To activate two of the Flexicook areas into a single zone, first select the cooking zone, then press the Flexicook () button. The indicator above the corresponding Flexicook control button lights up. Slide the scroll keypad for the desired power level.

To deactivate the Flexicook areas

To deactivate the Flexicook area press the Flexicook () button. When the power level indicator flashes, press the Flexicook () button again. The Flexicook indicator light will be off when deactivated.

Child Lock Safety Control

You can lock the controls to prevent unintended use (for example children accidentally turning the cooking zones on) by activating the Child Lock function.

To lock the controls

The cooking time indicator will show “Lo” and the Child Lock function is activated.

To unlock the controls

1. Make sure the induction cooktop is turned on.
2. Touch and hold the Child Lock control button  around 3 seconds, the buzzer beeps once and “Lo” disappears in timer indicator, the Child Lock is deactivated.

3. You can now start using your induction cooktop.



All controls are disabled when the Child Lock is activated except the ON/OFF control button  and Child Lock  control button.

In an emergency event, turn off the cooktop with the ON/OFF button .

If the cooktop is turned off without unlocking the Child Lock function, the Child Lock function will still remain active when the cooktop is turn on later.

You will have to unlock first then the cooktop can be turned on.

Stop & Go function

Make cooking easy! When cooking, your doorbell rings, phone rings, or kid shouts from another door. Need to step out of kitchen? These means dinner could be burnt, or take longer time to be ready if you switch everything off.

The **Stop & Go** function will turn off all zones. With one touch of the  button, the cooktop will resume the cooking.

1. Activate Stop & Go function

To activate **Stop & Go** function, press the  function button once. Then all programmer settings be hold on and the cooktop stops heating, all active zones' power level indicator show "P".

2. Deactivate Stop & Go function

To cancel **Stop & Go** function, press the **Stop & Go** function again, all programmer settings will return to its original power setting and the indicator "P" will disappear from all active zones' power level indicators.



When **Stop & Go** function is active, all control buttons are disabled except the ON/OFF, Stop & Go and Child Lock control button.

Note: The cooktop will turn off automatically if the Stop & Go function lasted for more than 10 minutes.

Using the Timer

When the cooktop is turned on, you can use the timer in two different ways:

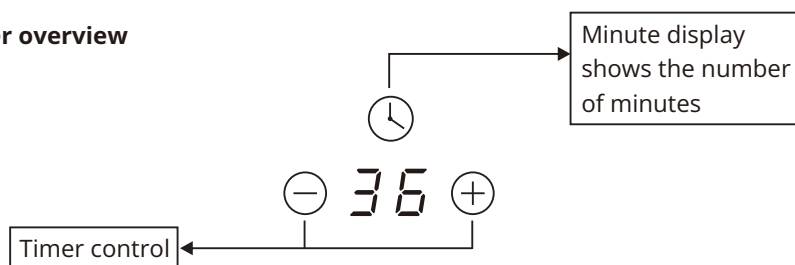

- You can use it as a minute minder. In this case, the timer will not turn any cooking zone off when the set time is up.
- You can set it to turn either or more than one cooking zones off.
- You can set the minute minder/timer for up to 99 minutes.

Timer overview



Using the Timer as a Minute Minder

Ensure the cooking zones are not selected

1. Touch the timer control button , the number in the timer indicator flashes.
 2. You can adjust the minute minder single digit by sliding the scroll keypad.
 3. Touch the timer control button  again, you can adjust the minute minder tens digit by slider the scroll keypad.
- To confirm, press the timer control button.

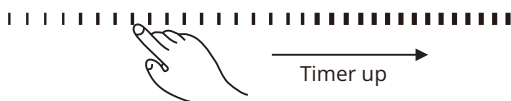
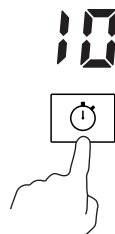

Note: The minute minder works in the following sequence: “Single Digit - Tens Digit”. The timer can set up to 99 mins.

When the minute minder is set, it will begin to count down immediately, the display will show the remaining time. The red dot next to timer indicator will flash.

Buzzer will beep for 30 seconds and timer indicator shows “-” when the setting time finished. Any efficient touching of control buttons during it, would end up the buzzer beeps.

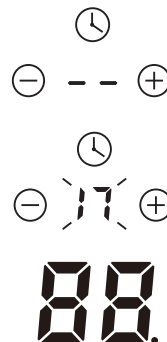

Setting the timer to turn cooking zone off

1.Touch the heating zone selection control button to select the cooking zone you wish to set timer for.

2.Touch the timer control button  the number in timer indicator flashing.

3.Then adjust Timer setting

- Touch the timer control button once, the number of single digit in timer indicator flashing, then adjust single digit of minute minder setting by sliding the slider control.
- Press the timer control button again, the number of tens digit in timer indicator flashing, then adjust tens digit of minute minder setting by sliding the slider control.

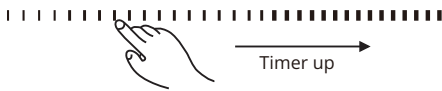

Note: By continuous touch the timer control button, the slider works at below consequence: "Single Digit-Tens Digit-Confirm Setting -Single Digit-..."

4.When the timer is set, it will begin to count down immediately, the display will show the remaining time.

NOTE: The red dot next to power level indicator will illuminate for those zones be set with timer. You can check timer setting of different cooking zone which set with timer, by active this cooking zone.

NOTE: If more than one heating zone has timer setting, the timer indicator will show the lowest time. The red dot next to power level indicator will flash.

5.When cooking timer expires, the corresponding cooking zone will be switch off automatically.

Note: The default setting of minute minder and timer is 30 minutes.

Note: After adjusting, the setting in timer indicator will be flashing for 5 seconds and then stop flashing, then the setting be confirmed.

Note: The minute minder and timer can be use at the same time, timer indicator shows the lowest time setting. If the lowest setting is minute minder, the red dot next to timer indicator will flash. If the lowest setting is timer setting, the red dot of corresponding cooking zone power level indicator will flash.

Note: If indicator shows timer setting of cooking zone. To check minute minder setting, press the timer control button , the indicator will show minute reminder setting.

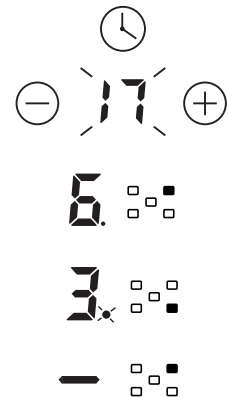
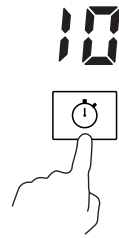

Detection of Pan and Small Articles

For induction cooktop, If the cooking level indicator flashes”  “alternately with heat setting.

- you have not placed a pan on the correct cooking zone or,
- the pan you’re using is not suitable for induction cooking or,
- Refer to Suggested Cookware Dimensions for more information.

Notes:

- 1.No heating takes place unless there is a suitable pan on the cooking zone.
- 2.The display will turn off automatically after 2 minutes if no suitable pan is placed on it.
- 3.When an unsuitable size or non-magnetic pan (e.g. aluminum), or some other small item (e.g. knife, fork, key) has been left on the cooktop, the corresponding cooking zone will turn off automatically in 1 minute.

Residual Heat Warning

Beware of hot surfaces

When the cooktop has been operating for some time, there will be some residual heat. The letter “ H ”appears in cooking level indicator to warn you to keep away from it.



It can also be used as an energy saving function:

If you want to heat up your pans, you may use the cooking zone when it is still hot.

Auto Shutdown

Another safety feature of the cooktop is auto shutdown feature. This is useful when you forget to switch off the cooktop after cooking. The default shutdown times as below table:

Power level	1	2	3	4	5	6	7	8	9
Default working timer (hour)	8	8	8	4	4	4	2	2	2

Over-heat Protection

A temperature sensor equipped can monitor the temperature inside the cooktop. When an excessive temperature is monitored, the cooktop will auto stop operation.

Over-flow Protection

For your safety, the induction cooktop will shut off the power automatically if boiling liquid spilled over or wet cloth touching the control panel. All control buttons became invalid except ON/OFF and Child Lock button. Keep the control panel dry to resume operation.

Cooking Guidelines

Be careful when frying as the oil and fat heat up quickly, particularly if you are using the Booster function. At extremely high temperature, oil and fat will ignite spontaneously and this presents a risk of fire.

Cooking Tips

- Lower the power setting when food comes to boil.
- Using a lid will reduce cooking times and save energy by retaining the heat.
- Minimize the amount of liquid or fat to reduce cooking times.
- Start cooking on a high setting and reduce the setting when the food has heated through.

Simmering, cooking rice

- Simmering occurs below boiling point, at around 85°C, when bubbles are just rising occasionally to the surface of the cooking liquid. It is the key to delicious soups and tender stews because flavors develop without overcooking the food. You should also cook egg-based and flour thickened sauces below boiling point.
- Some tasks, including cooking rice by the absorption method, may require a setting higher than the lowest setting to ensure the food is cooked properly in the time recommended.

Searing steak

To cook juicy flavorsome steaks:

1. Bring the meat to room temperature before cooking.
2. Heat up a heavy-based frying pan.
3. Brush both sides of the steak with oil. Drizzle a small amount of oil into the hot pan and then put the meat onto the hot pan.
4. Flip the steak only once during cooking. The exact cooking time will depend on the thickness of the steak and how you would like the steak to be cooked. Cooking time may vary from about 2-8 minutes per side.
5. Rest the steak on a warm plate for a few minutes to allow everything to relax and redistribute the juice, which creates a more tender, juicier cut.

Cleaning and Maintenance

Important: Before any maintenance or cleaning work is carried out, DISCONNECT the appliance from ELECTRICITY supply and ensure the appliances is completely cool.

Cleaning the cooktop Surface

Clean spillages from the cooktop surface as soon as possible after use. Always ensure the surface is cool enough before cleaning.

Use a soft cloth or kitchen paper to clean the surface. If the spillage has dried on the surface, you may need to use a specialist vitro-ceramic glass cleaner, which is available for most of supermarkets.

Do not use other abrasive cleaners and/or wire wool ect., as it may scratch the ceramic glass surface of your cooktop.

Damage from Sugary Spills and Melted Plastic

Special care should be taken when removing hot substances to avoid permanent damage of the glass surface.

Sugary spillovers (such as jellies, fudge, candy, syrups) or melted plastics can cause pitting of the surface of your cooktop (not covered by the warranty) unless the spill is removed while still hot. Special care should be taken when removing hot substances.

Hints and Tips

What?	How?	Important!
<p>Everyday soiling on glass (fingerprints, marks, stains left by food or non-sugary spillovers on the glass)</p>	<ol style="list-style-type: none"> 1. Switch off the power supply. 2. Apply a vitro-ceramic glass cleaner while the glass is still warm (but not hot!) 3. Rinse and wipe dry with a clean cloth or paper towel. 4. Switch on the power supply to the cooktop. 	<ul style="list-style-type: none"> • When turn off the power supply of cooktop, there will be no 'hot surface' indication but the cooking zone may still be hot! Take extreme care. • Heavy-duty scourers, some nylon scourers and harsh/abrasive cleaning agents may scratch the glass. Always read the label to check if your cleaner or scourer is suitable. • Never leave cleaning residue on the cooktop glass surface: the glass may become stained.
<p>Boil over, melts, and hot sugary spills on the glass</p>	<p>Remove these immediately with a fish slice, palette knife or razor blade scraper suitable for ceramic glass of cooktop, but beware of hot cooking zone surfaces:</p> <ol style="list-style-type: none"> 1. Switch off the power supply. 2. Hold the blade or utensil at a 30° angle and scrape the soiling or spill to a cool area of the cooktop. 3. Clean the soiling or spill up with a dish cloth or paper towel. 4. Follow steps 2 to 4 for 'Everyday soiling on glass' above. 	<ul style="list-style-type: none"> • Remove stains left by melts and sugary food or spillovers as soon as possible. If left to cool on the glass, they may be difficult to remove or even permanently damage the glass surface. • Cut hazard: when the safety cover is retracted, the blade in a scraper is razor-sharp. Use with extreme care and always store safely and out of reach of children.
<p>Spillovers on the touch controls</p>	<ol style="list-style-type: none"> 1. Switch off the power supply. 2. Soak up the spill 3. Wipe the touch control area with a clean damp sponge or cloth. 4. Wipe the area completely dry with a paper towel. 5. Switch on the power supply to the cooktop. 	<ul style="list-style-type: none"> • The cooktop may beep and turn itself off, and the touch controls may not function while there is liquid on them. Make sure you wipe the touch control area dry before turning the cooktop back on.

Troubleshooting

If you find something goes wrong for your cooktop, before contact the service or where you purchased it, please check whether below:

1. There is no power to the appliance:

- Check whether there is a power cut of your department;
- Check whether the appliance be connected to electricity properly;
- Has the timer setting elapsed;
- Whether it reaches the longest cooking time setting and auto shut off;
- Whether there is liquid boiling over touch control panel and overflow protection devices auto shut off;

2. The touch control panel buttons can't be active:

- Whether it's under "Child Lock", which there is "Lo" shows in timer displayer;
- Whether liquid/wet cloth over touch control panel active overflow protection;

3. After cooking there is "H" shows on display:

- This is normal. The cooktop is with Residual Heat Warning safety features. It will remain on until the surface is cool enough for touch.

4. After turn off, the fan of induction cooktop remains working for a while:

- This is normal, this is to help appliances completely cool down.

5. Some pans make crackling or clicking noises during use of induction cooktop:

- This is normal, it's the sound of induction coils during working, and for different construction of your cookware, the clicking might be slightly different.

6. The glass is being scratched:



- Check whether you use unsuitable cookware, like rough-edged cookware.
- Check whether unsuitable, abrasive scourer or cleaning products being used.

Technical Specifications

Model No.	IWHH9050CC
Rated Voltage & Frequency	220-240V~ or 380-415V 3N~, 50-60Hz
Rated Power	10200W
Product Size	900*520*60mm
Carton Size	990*598*118mm
Net Weight	16.46 kg
Gross Weight	18.17 kg

Weight and Dimensions are approximate. Because we continually strive to improve our products we may change specifications and designs without prior notice.

If an abnormality comes up, the induction cooktop will enter the protective state automatically and display corresponding protective codes:

Problem	Possible causes	What to do
E1/E2	Abnormal supply voltage	Please check whether power supply is normal, Power on after the power supply is normal.
E3	High temperature of the pan sensor	Check whether no liquid in pan, fill with liquid then restart.
E5	High temperature of the IGBT temperature sensor	Please restart after the induction cooktop cools down.
	<p>1.If a pan is too small for the induction zone, it can still be used. However, if the pan is a lot smaller than the zone, you may find that the induction cooktop won't activate when the pan is placed in the zone. This is simply because the pan is too small to register on the magnets.</p> <p>2.Wrong pot size used by the customer.</p> <p>3.Pot not appropriate for induction cooktops.</p>	<p>1.The cooking zones will not switch on if pots are not the right size. Only use pots bearing the symbol "INDUCTION SYSTEM"</p>  <p>2.Use a magnet to check if the bottom of the pot is suitable for the induction cooktop: bottom of the pots and pans are unsuitable if not magnetically detectable.</p>

For all other error codes, switch off and call Customer Service.

After-sales service

To receive complete assistance, please register your product in your local market.

BEFORE CALLING THE AFTER-SALE SERVICE:

1. See if you can solve the problem by yourself with the help of the TROUBLESHOOTING suggestions.
2. Switch the appliance off and on again to see if the fault persists.

IF AFTER THE ABOVE CHECKS THE FAULT STILL OCCURS, GET IN TOUCH WITH THE NEAREST AFTER-SALES SERVICE.

To receive assistance, call the number shown on the warranty booklet or follow the website's instructions.

When contacting our Client After sales service, always specify:

- a brief description of the fault;
- the type and exact model of the appliance;
- the serial number(on the rating plate located under the appliance);
- your full address;
- your telephone number.

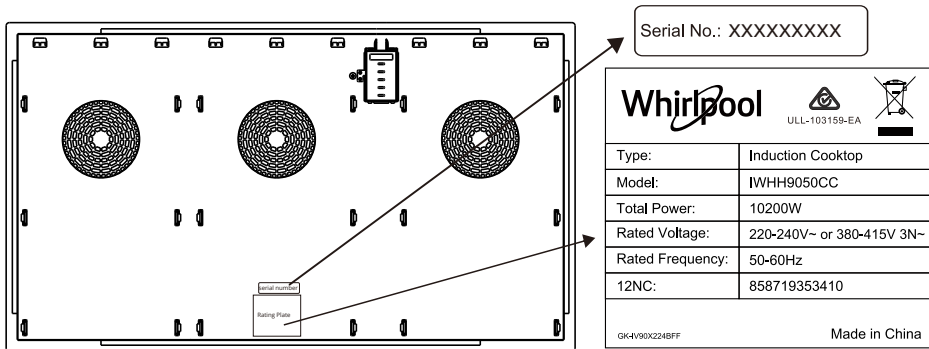

If any repairs are required, please contact an authorized after-sales service (to guarantee that original spare parts will be used and repairs carried out correctly).

REGISTER YOUR PRODUCT ONLINE

For Australia Market



Scan QR Code or visit
www.whirlpool.com.au
to register your product warranty online.

This QR Code is only applicable to Australia.
You can download the user manual by

- Visiting our website www.whirlpool.com.au
- Contracting our Customer Service Center at 1300 363 344

For New Zealand Market



Scan QR Code or visit
www.whirlpool.co.nz
to register your product warranty online.

This QR Code is only applicable to New Zealand.
You can download the user manual by

- Visiting our website www.whirlpool.co.nz
- Contracting our Customer Service Center at 0800 442 584

Whirlpool® Registered trademark/TM Trademark of Whirlpool group of companies

All rights reserved -<http://www.whirlpool.com.au>

-<http://www.whirlpool.co.nz>



Whirlpool