

WS6VMH60W2AUS
WS6VMH60X2AUS

Whirlpool

Contents

Warning, 3-4

Installation, 5

Positioning and levelling
Electrical connection
Technical data

Description of the appliance, 7

Overall view
Control panel

Start-up and use, 8

Starting the oven
Using the cooking timer

Cooking advice, 10

Oven cooking advice table

Using the glass ceramic hob, 11

Switching the cooking zones on and off
Cooking zones

Precautions and tips, 12

General safety
Disposal
Respecting and conserving the environment

Care and maintenance, 13

Switching the appliance off
Cleaning the appliance
Replacing the oven light bulb
Cleaning the glass ceramic hob
Assistance

SAFETY INSTRUCTIONS

IMPORTANT TO BE READ AND OBSERVED

Before using the appliance, read these safety instructions. Keep them nearby for future reference.

These instructions and the appliance itself provide important safety warnings, to be observed at all times. The manufacturer declines any liability for failure to observe these safety instructions, for inappropriate use of the appliance or incorrect setting of controls.

⚠ WARNING: The appliance and its accessible parts become hot during use. Care should be taken to avoid touching heating elements. Children less than 8 years of age must be kept away unless continuously supervised.

⚠ WARNING : If the hob surface is cracked, do not use the appliance – risk of electric shock.

⚠ WARNING : Danger of fire : Do not store items on the cooking surfaces.

⚠ CAUTION : The cooking process has to be supervised. A short cooking process has to be supervised continuously.

⚠ WARNING: Leaving the hob unattended when cooking with fat or oil can be dangerous – risk of fire. NEVER try to extinguish a fire with water, but switch off the appliance and then cover the flames e.g. with a lid or a fire blanket.

⚠ Do not use the hob as a work surface or support. Keep clothes or other flammable materials away from the appliance, until all the components have cooled down completely – risk of fire.

⚠ Very young children (0-3 years) should be kept away from the appliance. Young children (3-8 years) should be kept away from the appliance unless continuously supervised. Children from 8 years old and above and persons with reduced physical, sensory or mental capabilities or lack of experience and knowledge can use this appliance only if they are supervised or have been given instructions on safe use and understand the hazards involved. Children must not play with the appliance. Cleaning and user maintenance must not be carried out by children without supervision.

⚠ WARNING: The appliance and its accessible parts become hot during use. Care should be taken to avoid touching heating elements. Children less than 8 years of age must be kept away unless continuously supervised

⚠ Never leave the appliance unattended during food drying. If the appliance is suitable for probe usage, only use a temperature probe recommended for this oven - risk of fire.

⚠ Keep clothes or other flammable materials away from the appliance, until all the components have cooled down completely - risk of fire. Always

be vigilant when cooking foods rich in fat, oil or when adding alcoholic beverages - risk of fire. Use oven gloves to remove pans and accessories. At the end of cooking, open the door with caution, allowing hot air or steam to escape gradually before accessing the cavity - risk of burns. Do not obstruct hot air vents at the front of the oven - risk of fire.

⚠ Exercise caution when the oven door is in the open or down position, to avoid hitting the door.

PERMITTED USE

⚠ CAUTION: The appliance is not intended to be operated by means of an external switching device, such as a timer, or separate remote controlled system.

⚠ This appliance is intended to be used in household and similar applications such as: staff kitchen areas in shops, offices and other working environments; farm houses; by clients in hotels, motels, bed & breakfast and other residential environments.

⚠ No other use is permitted (e.g. heating rooms).

⚠ This appliance is not for professional use. Do not use the appliance outdoors.

⚠ Do not store explosive or flammable substances (e.g. gasoline or aerosol cans) inside or near the appliance - risk of fire.

INSTALLATION

⚠ The appliance must be handled and installed by two or more persons - risk of injury. Use protective gloves to unpack and install - risk of cuts.

⚠ Installation, including water supply (if any), electrical connections and repairs must be carried out by a qualified technician. Do not repair or replace any part of the appliance unless specifically stated in the user manual. Keep children away from the installation site. After unpacking the appliance, make sure that it has not been damaged during transport. In the event of problems, contact the dealer or your nearest Aftersales Service. Once installed, packaging waste (plastic, styrofoam parts etc.) must be stored out of reach of children - risk of suffocation. The appliance must be disconnected from the power supply before any installation operation - risk of electric shock. During installation, make sure the appliance does not damage the power cable - risk of fire or electric shock. Only activate the appliance when the installation has been completed.

Do not remove the appliance from its polystyrene foam base until the time of installation.

⚠ Do not install the appliance behind a decorative door - risk of fire.



if the range is placed on a base, it must be leveled and fixed to the wall by the retention chain provided, to prevent the appliance slipping from the base.



WARNING: In order to prevent the appliance from tipping, the retention chain provided must be installed. Refer to the instructions for installation.

ELECTRICAL WARNINGS

⚠ The rating plate is on the front edge of the oven (visible when the door is open).

⚠ It must be possible to disconnect the appliance from the power supply by unplugging it if plug is accessible, or by a multi-pole switch installed upstream of the socket in accordance with the wiring rules and the appliance must be earthed in conformity with national electrical safety standards.

⚠ Do not use extension leads, multiple sockets or adapters. The electrical components must not be accessible to the user after installation. Do not use the appliance when you are wet or barefoot. Do not operate this appliance if it has a damaged power cable or plug, if it is not working properly, or if it has been damaged or dropped.

⚠ If the supply cord is damaged, it must be replaced with an identical one by the manufacturer, its service agent or similarly qualified persons in order to avoid a hazard - risk of electric shock.

⚠ If the power cable needs to be replaced, contact an authorized service center.

⚠ **WARNING:** Ensure that the appliance is switched off before replacing the lamp to avoid the possibility of electric shock.

CLEANING AND MAINTENANCE

⚠ **WARNING:** Ensure that the appliance is switched off and disconnected from the power supply before performing any maintenance operation; never use steam cleaning equipment - risk of electric shock.

⚠ Do not use harsh abrasive cleaners or metal scrapers to clean the door glass since they can scratch the surface, which may result in shattering of the glass.

⚠ Do not use abrasive or corrosive products, chlorine-based cleaners or pan scourers.

⚠ Make sure the appliance has cooled down before cleaning or performing maintenance. - risk of burns.

⚠ **WARNING:** Switch off the appliance before replacing the lamp - risk of electric shock.

DISPOSAL OF PACKAGING MATERIALS

The packaging material is 100% recyclable and is marked with the recycle symbol . The various parts of the packaging must therefore be disposed of responsibly and in full compliance with local authority regulations governing waste disposal.

DISPOSAL OF HOUSEHOLD APPLIANCES

This appliance is manufactured with recyclable or reusable materials. Dispose of it in accordance with local waste disposal regulations.



For further information on the treatment, recovery and recycling of household electrical appliances, contact your local authority, the collection service for household waste or the store where you purchased the appliance. This appliance is marked in compliance with European Directive 2012/19/EU, Waste Electrical and Electronic Equipment (WEEE). By ensuring this product is disposed of correctly, you will help prevent negative consequences for the environment and human health. The symbol  on the product or on the accompanying documentation indicates that it should not be treated as domestic waste but must be taken to an appropriate collection centre for the recycling of electrical and electronic equipment.

ENERGY SAVING TIPS

Only preheat the oven if specified in the cooking table or your recipe. Use dark lacquered or enamelled baking trays as they absorb heat better.

DECLARATIONS OF CONFORMITY

This appliance meets Ecodesign requirements of European Regulation 66/2014 in compliance with the European standard EN 60350-1.

This appliance meets Ecodesign requirements of European Regulation 66/2014 in compliance with the European standard EN 60350-2.

INSTALLATION

Before operating your new appliance please read this instruction booklet carefully. It contains important information concerning the safe installation and operation of the appliance.

Please keep these operating instructions for future reference. Make sure that the instructions are kept with the appliance if it is sold, given away or moved.

The appliance must be installed by a qualified professional according to the instructions provided.

Any necessary adjustment or maintenance must be performed after the appliance has been disconnected from the electricity supply.

Positioning and levelling

It is possible to install the appliance alongside cupboards whose height does not exceed that of the hob surface.

This cooker should be installed directly on the floor. Do not install this cooker on an artificial base of any kind.

Make sure that the wall in contact with the back of the appliance is made from a non-flammable, heat-resistant material (T 90°C).

Important: Do not install this appliance adjacent to the door or other means of access to minimise the likelihood of persons using the door making contact with pans on the hob surface.

To install the appliance correctly:

- Place it in the kitchen, dining room or the bed-sit (not in the bathroom).
- If the top of the hob is higher than the cupboards, the appliance must be installed at least 200 mm away from them.

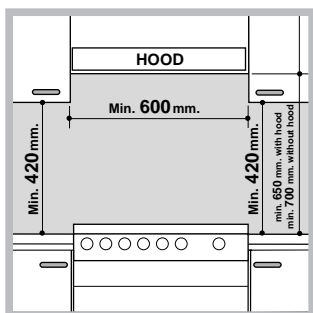

- If the cooker is installed underneath a wall cabinet, there must be a minimum distance of 420 mm between this cabinet and the top of the hob.

This distance should be increased to 700 mm if the wall cabinets are flammable (see figure).

- Do not position blinds behind the cooker or less than 200 mm away from its sides.
- Any hoods must be installed according to the instructions listed in the relevant operating manual.

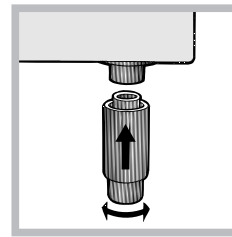

Levelling

If it is necessary to level the appliance, screw the adjustable feet* into the places provided on each corner of the base of the cooker (see figure).

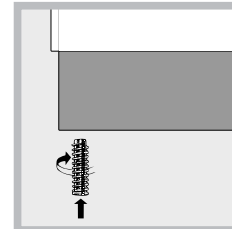

The legs* provided with the appliance fit into the slots on the underside of the base of the cooker.

The appliance must not be installed behind a decorative door in order to avoid overheating

Electrical connection

Ovens with a three-pole power supply cable are designed to operate with alternated current at the supply frequency and voltage indicated on the data plate (at the bottom of the oven dashboard). The earthing conductor of the cable is the yellow-green conductor.

Opening the terminal board:

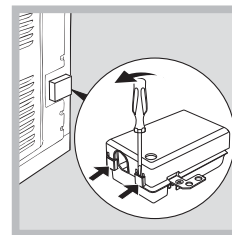

- Using a screwdriver, prise on the side tabs of the terminal board cover;
- Pull open the cover of the terminal board.

To install the cable, proceed as follows:

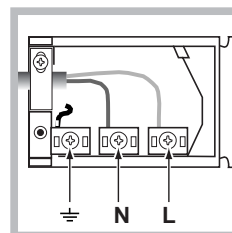

- Remove the wire clamp screw and the three contact screws L-N-⏏
- Fasten the wires beneath the heads of the screws using the following color scheme : **Blue (N) Brown (L) Yellow-Green ⏏**

- Fasten the supply cable in place with the clamp and close the cover of the terminal board.

Connecting the supply cable to the mains

WARNINGS: THIS APPLIANCE MUST BE EARTHED.

The cooker must be connected to the mains by a switched (double pole) cooker outlet correctly fused with a capacity appropriate to that shown on the cooker Rating Plate. All electrical wiring from the consumer unit to the cooker, via the switched double pole cooker outlet, must be of an acceptable type and current rating as above.

the supply cable must be positioned so that it

never reaches at any point a temperature 50°C higher than the room temperature. The cable must be routed away from the rear vents.

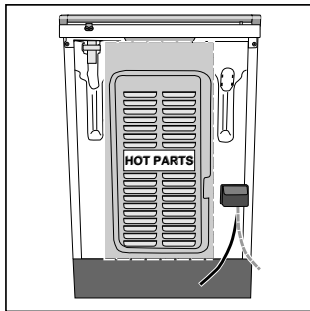

The manufacturer declines any liability should these safety measures not be observed.

We recommend cleaning the oven before using it for the first time, following the instructions provided in the "Care and maintenance" section.

If the supply cord is damaged, it must be replaced by the manufacturer, its service agent or similarly qualified persons in order to avoid a hazard.

Safety Chain

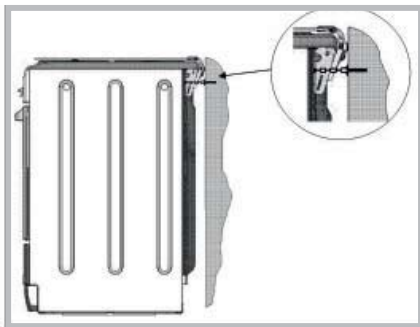

In order to prevent accidental tipping of the appliance, for example by a child climbing onto the oven door, the supplied safety chain **MUST** be installed!

The cooker is fitted with a safety chain to be fixed by means of a screw (not supplied with the cooker) to the wall behind the appliance, at the same height as the chain is attached to the appliance.

Choose the screw and the screw anchor according to the type of material of the wall behind the appliance. If the head of the screw has a diameter smaller than 9mm, a washer should be used. Concrete wall requires the screw of at least 8mm of diameter, and 60mm of length.

Ensure that the chain is fixed to the rear wall of the cooker and to the wall, as shown in figure, so that after installation it is tensioned and parallel to the ground level.

TABLE OF CHARACTERISTICS	
Oven dimensions (HxWxD)	32x43.5x40 cm
Volume	58 l
Useful measurements relating to the oven compartment	width 42 cm depth 44 cm height 8.5 cm
Voltage and frequency	see data plate Data plate, is located inside the flap or, after the oven compartment has been opened, on the left-hand wall inside the oven.
Ceramic hob Front Left Back Left Back Right Front Right Max. ceramic hob consumption	1700 W 1200 W 2100 W 1200 W 6200 W
ENERGY LABEL	Directive 2002/40/EC on the label of electric ovens. Standard EN 50304 Natural convection energy consumption heating mode: <input type="checkbox"/> Traditional mode Declared forced convection energy consumption heating mode: <input checked="" type="checkbox"/> Multilevel.
	This appliance conforms to the following European Economic Community directives: 2006/95/EC dated 12/12/06 (Low Voltage) and subsequent amendments - 2004/108/EC dated 15/12/04 (Electromagnetic Compatibility) and subsequent amendments - 93/68/EEC dated 22/07/93 and subsequent amendments. 2002/96/EC 1275/2008 (Stand-by/Off mode)

DAILY REFERENCE GUIDE



Read the safety instructions carefully before using the product

PRODUCT DESCRIPTION

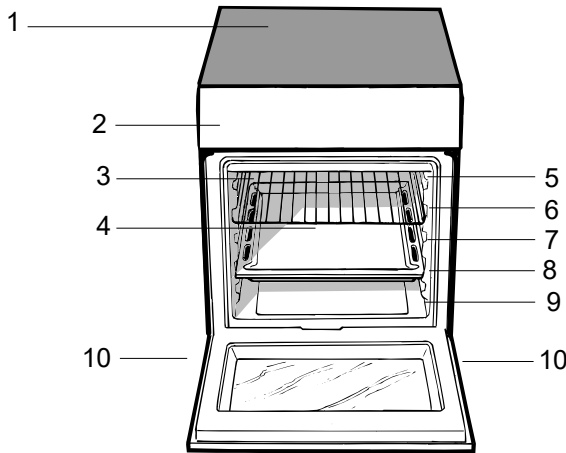

- 1. **Glass ceramic hob**
- 2. **Control panel**
- 3. **GRILL rack**
- 4. **DRIPPING pan**
- GUIDE RAILS**
for the sliding racks
- 5. **position 5**
- 6. **position 4**
- 7. **position 3**
- 8. **position 2**
- 9. **position 1**
- 10. **Adjustable foot**

CONTROL PANEL

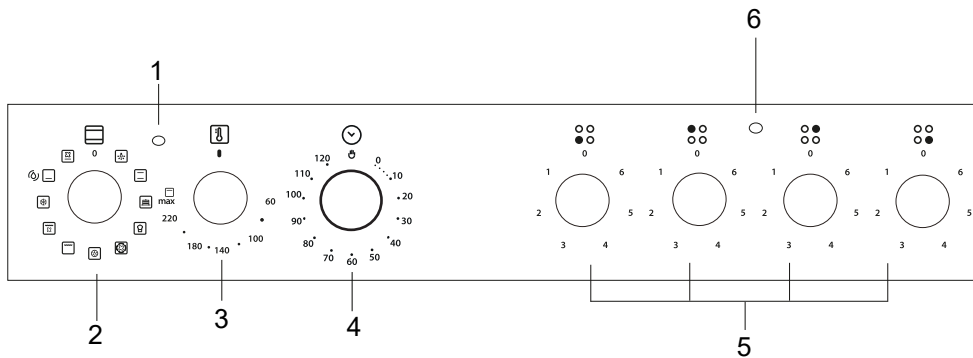

- 1. **THERMOSTAT**
indicator light
- 2. **SELECTOR**
knob
- 3. **THERMOSTAT**
knob

- 4. **COOKING TIMER**
knob
- 5. **ELECTRIC HOTPLATE**
control knobs
- 6. **ACTIVE HOTPLATE**
indicator light

START-UP AND USE

Using the oven

The first time you use your appliance, heat the empty oven with its door closed at its maximum temperature for at least half an hour. Ensure that the room is well ventilated before switching the oven off and opening the oven door.

The appliance may emit a slightly unpleasant odour caused by protective substances used during the manufacturing process burning away.

Never put objects directly on the bottom of the oven; this will avoid the enamel coating being damaged.

1. Select the desired cooking mode by turning the SELECTOR knob.
2. Select the recommended temperature for the cooking mode or the desired temperature by turning the THERMOSTAT knob.

A list detailing cooking modes and suggested cooking temperatures can be found in the relevant table (see Oven cooking advice table).

During cooking it is always possible to:

- Change the cooking mode by turning the SELECTOR knob.
- Change the temperature by turning the THERMOSTAT knob.
- Stop cooking by turning the SELECTOR knob to the "0" position.

Always place cookware on the rack(s) provided.

THERMOSTAT indicator light

When this is illuminated, the oven is generating heat. It switches off when the inside of the oven reaches the selected temperature. At this point the light illuminates and switches off alternately, indicating that the thermostat is working and is All If maintaining the temperature at a constant level.

OPERATION indicator light

When this is illuminated, the oven is generating heat.

Oven light

This is switched on by turning the SELECTOR knob to any position other than "0". It remains lit as long as the oven is operating. By selecting  with the knob, the light is switched on without any of the heating elements being activated.

Installing the shelves

When inserting the shelves onto the guide rails, ensure the raised section is towards the rear of the oven. This prevents food from falling off the back of the tray.

Cooking modes

! A temperature value can be set for all cooking modes between 60°C and Max, except for the following modes

- GRILL (recommended: set only to MAX power level)
- GRATIN (recommended: do not exceed 200°C).



TRADITIONAL OVEN mode

Both the top and bottom heating elements will come on. When using this traditional cooking mode, it is best to use one cooking rack only. If more than one rack is used, the heat will be distributed in an uneven manner.



BAKING mode

The rear heating element and the fan are switched on, thus guaranteeing the distribution of heat in a delicate and uniform manner throughout the entire oven. This mode is ideal for baking and cooking temperature sensitive foods (such as cakes that need to rise) and for the preparation of pastries on 3 shelves simultaneously.



FAST COOKING mode

The heating elements and the fan come on, guaranteeing the distribution of heat consistently and uniformly throughout the oven.

Preheating is not necessary for this cooking mode. This mode is particularly suitable for cooking pre-packed food quickly (frozen or pre-cooked). The best results are achieved using one cooking rack only.



MULTI-COOKING mode

All the heating elements (top, bottom and circular) switch on and the fan begins to operate. Since the heat remains constant throughout the oven, the air cooks and browns food in a uniform manner. A maximum of two racks may be used at the same time.



PIZZA mode

The circular heating elements and the elements at the bottom of the oven are switched on and the fan is activated. This combination heats the oven rapidly by producing a considerable amount of heat, particularly from the element at the bottom. If you use more than one rack at a time, switch the position of the dishes halfway through the cooking process.

 GRILL mode

The central part of the top heating element is switched on. The high and direct temperature of the grill is recommended for food that requires a high surface temperature (veal and beef steaks, fillet steak and entrecôte). This cooking mode uses a limited amount of energy and is ideal for grilling small dishes. Place the food in the centre of the rack, as it will not be cooked properly if it is placed in the corners.

 GRATIN mode

The top heating element and the rotisserie (where present) are activated and the fan begins to operate. This combination of features increases the effectiveness of the unidirectional thermal radiation provided by the heating elements through forced circulation of the air throughout the oven. This helps prevent food from burning on the surface and allows the heat to penetrate right into the food.

The GRILL and GRATIN cooking modes must be performed with the oven door shut.

 DEFROSTING mode

The fan located on the bottom of the oven makes the air circulate at room temperature around the food. This is recommended for the defrosting of all types of food, but in particular for delicate types of food which do not require heat, such as for example: ice cream cakes, cream or custard desserts, fruit cakes. By using the fan, the defrosting time is approximately halved. In the case of meat, fish and bread, it is possible to accelerate the process using the "multi-cooking" mode and setting the temperature to 80° - 100°C.

 BOTTOM VENTILATED mode

The bottom heating element and the fan is activated, which allows for the heat distribution within the whole cavity of the oven. This combination is useful for light cooking of vegetables and fish.

 BOTTOM mode

The lower heating element is activated. This position is recommended for perfecting the cooking of dishes (in baking trays) which are already cooked on the surface but require further cooking in the centre, or for desserts with a covering of fruit or jam, which only require moderate colouring on the surface. It should be noted that this function does not allow the maximum temperature to be reached inside the oven (250°C) and it is therefore not recommended that foods are cooked using only this setting, unless you are baking cakes (which should be baked at a temperature of 180°C or lower).

Practical cooking advice

In the GRILL cooking mode, place the dripping pan in position 1 to collect cooking residues (fat and/or grease).

GRILL

- Insert the rack in position 3 or 4. Place the food in the centre of the rack.
- We recommend that the power level is set to maximum. The top heating element is regulated by a thermostat and may not always operate constantly.

PIZZA

- Use a light aluminium pizza pan. Place it on the rack provided.
For a crispy crust, do not use the dripping pan as it prevents the crust from forming by extending the total cooking time.
- If the pizza has a lot of toppings, we recommend adding the mozzarella cheese on top of the pizza halfway through the cooking process.

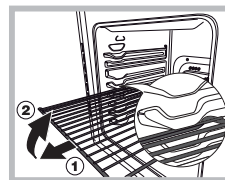

WARNING! The oven is provided with a stop system to extract the racks and prevent them from coming out of the oven.(1)
As shown in the drawing, to extract them completely, simply lift the racks, holding them on the front part, and pull (2).

Using the cooking timer

1. To set the buzzer, turn the COOKING TIMER knob clockwise almost one complete revolution.
2. Turn the knob anticlockwise to set the desired time: align the minutes shown on the COOKING TIMER knob with the indicator on the control panel.
3. When the selected time has elapsed, a buzzer sounds and the oven turns off.
4. When the oven is off the cooking timer can be used as a normal timer.

To use the oven manually, in other words when you do not wish to use the end of cooking timer, turn the COOKING TIMER knob until it reaches the  symbol.

OVEN COOKING ADVICE TABLE

Cooking modes	Foods	Weight (in kg)	Rack Position	Pre-heating time (minutes)	Recommended temperature	Cooking time (minutes)
Traditional Oven	Duck	1	3	15	200	65-75
	Roast veal or beef	1	3	15	200	70-75
	Pork roast	1	3	15	200	70-80
	Biscuits (short pastry)	-	3	15	180	15-20
	Tarts	1	3	15	180	30-35
Baking Mode	Tarts	0.5	3	15	180	20-30
	Fruit cakes	1	2 or 3	15	180	40-45
	Plum cake	0.7	3	15	180	40-50
	Sponge cake	0.5	3	15	160	25-30
	Stuffed pancakes (on 2 racks)	1.2	2 and 4	15	200	30-35
	Small cakes (on 2 racks)	0.6	2 and 4	15	190	20-25
	Cheese puffs (on 2 racks)	0.4	2 and 4	15	210	15-20
	Cream puffs (on 3 racks)	0.7	1 and 3 and 5	15	180	20-25
	Biscuits (on 3 racks)	0.7	1 and 3 and 5	15	180	20-25
	Meringues (on 3 racks)	0.5	1 and 3 and 5	15	90	180
	Fast cooking	Frozen food				
Pizza		0.3	2	-	250	12
Courgette and prawn pie		0.4	2	-	200	20
Country style spinach pie		0.5	2	-	220	30-35
Turnovers		0.3	2	-	200	25
Lasagne		0.5	2	-	200	35
Golden Rolls		0.4	2	-	180	25-30
Chicken morsels		0.4	2	-	220	15-20
Pre-cooked food						
Golden chicken wings		0.4	2	-	200	20-25
Fresh Food						
Biscuits (short pastry)		0.3	2	-	200	15-18
Plum cake		0.6	2	-	180	45
Cheese puffs	0.2	2	-	210	10-12	
Multi-cooking	Pizza (on 2 racks)	1	2 and 4	15	230	15-20
	Lasagne	1	3	10	180	30-35
	Lamb	1	2	10	180	40-45
	Roast chicken + potatoes	1+1	2 and 4	15	200	60-70
	Mackerel	1	2	10	180	30-35
	Plum cake	1	2	10	170	40-50
	Cream puffs (on 2 racks)	0.5	2 and 4	10	190	20-25
	Biscuits (on 2 racks)	0.5	2 and 4	10	180	10-15
	Sponge cake (on 1 rack)	0.5	2	10	170	15-20
	Sponge cake (on 2 racks)	1	2 and 4	10	170	20-25
	Savoury pies	1.5	3	15	200	25-30
	Pizza Mode	Pizza	0.5	3	15	220
Roast veal or beef		1	2	10	220	25-30
Chicken		1	2 or 3	10	180	60-70
Grill	Soles and cuttlefish	0.7	4	-	Max	10-12
	Squid and prawn kebabs	0.6	4	-	Max	8-10
	Cuttlefish	0.6	4	-	Max	10-15
	Cod filet	0.8	4	-	Max	10-15
	Grilled vegetables	0.4	3 or 4	-	Max	15-20
	Veal steak	0.8	4	-	Max	15-20
	Sausages	0.6	4	-	Max	15-20
	Hamburgers	0.6	4	-	Max	10-12
	Mackerels	1	4	-	Max	15-20
	Toasted sandwiches (or toast)	4 and 6	4	-	Max	3-5
	Gratin	Grilled chicken	1.5	2	10	200
Cuttlefish		1.5	2	10	200	30-35
Bottom Ventilated	Bream	0.5	3	18'	170-180	25-35
	Codfish fillet	0.5	3	16'	160-170	15-20
	Sea bass in foil	0.5	3	24'	200-210	35-45
	Mixed vegetables (Ratatouille type)	0.8 - 1,0	3	21'	190 -200	50 - 60
	Well-done vegetables	1,5 - 2,0	3	20'	180 - 190	55 - 60
Bottom	For perfecting cooking					

USING THE GLASS CERAMIC HOB

The glue applied on the gaskets leaves traces of grease on the glass. Before using the appliance, we recommend you remove these with a special non-abrasive cleaning product. During the first few hours of use there may be a smell of rubber which will disappear very quickly.

Switching the cooking zones on and off

To switch on a cooking zone, turn the corresponding knob in a clockwise direction.

To switch it off again, turn the knob in an anticlockwise direction until it is in the "0" position. If the COOKING ZONE ON indicator light is lit, this shows that at least one of the cooking zones on the hob is switched on.

Cooking zones

The hob is equipped with electric radiant heating elements. When they are in use the following items on the hob become red.

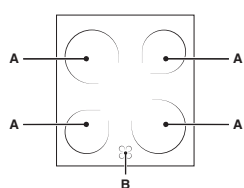

- A. The cooking zone with radiant heating elements.
B. The residual heat indicator light: this indicates that the temperature of the corresponding cooking zone is greater than 60°C, even

when the heating element has been switched off but is still hot.

Cooking zones with radiant heating elements.

The circular radiant heating elements become red 10 - 20 seconds after they have been switched on.

Setting	Normal or Fast Plate
0	Off
1	Cooking vegetables, fish
2	Cooking potatoes (using steam) soups, chickpeas, beans.
3	Continuing the cooking of large quantities of food, minestrone
4	For roasting (average)
5	For roasting (above average)
6	For browning and reaching a boil in a short time.

Practical advice on using the hob

- Use pans with a thick, flat base to ensure that they adhere perfectly to the cooking zone.

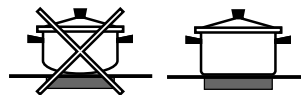

- Always use pans with a diameter that is large enough to cover the hotplate fully, in order to use all the heat produced.



- Always make sure that the base of the pan is completely clean and dry: this ensures that the pans adhere perfectly to the cooking zones and that both the pans and the hob remain effective for a longer period of time.
- Avoid using the same cookware that is used on gas burners: the heat concentration on gas burners may have warped the base of the pan, causing it not to adhere to the surface correctly.
- Never leave a cooking zone switched on without a pan on top of it, as doing so may cause the zone to become damaged.

PRECAUTIONS AND TIPS

This appliance has been designed and manufactured in compliance with international safety standards. The following warnings are provided for safety reasons and must be read carefully.

General safety

- These instructions are only valid for the countries whose symbols appear in the manual and on the serial number plate.
- The appliance was designed for domestic use inside the home and is not intended for commercial or industrial use.
- The appliance must not be installed outdoors, even in covered areas. It is extremely dangerous to leave the appliance exposed to rain and storms.
- Do not touch the appliance with bare feet or with wet or damp hands and feet.
- **The appliance must be used by adults only for the preparation of food, in accordance with the instructions outlined in this booklet. Any other use of the appliance (e.g. for heating the room) constitutes improper use and is dangerous. The manufacturer may not be held liable for any damage resulting from improper, incorrect and unreasonable use of the appliance.**
- The instruction booklet accompanies a class 1 (insulated) or class 2 - subclass 1 (recessed between 2 cupboards) appliance.
- When the appliance is in use, the heating elements and some parts of the oven door become extremely hot. Make sure you don't touch them and keep children well away.
- Make sure that the power supply cables of other electrical appliances do not come into contact with the hot parts of the oven.
- The openings used for the ventilation and dispersion of heat must never be covered.
- Do not place unstable or misshapen pans on the electric hotplates; this will help to avoid spills. Position them on the hob with the handles turned towards the centre of the appliance.
- Always use oven gloves when placing cookware in the oven or when removing it.
- Do not use flammable liquids (alcohol, petrol, etc...) near the appliance while it is in use.
- Do not place flammable material in the lower storage compartment or in the oven itself. If the appliance is switched on accidentally, it could catch fire.
- Always make sure the knobs are in the '0' position when the appliance is not in use.
- When unplugging the appliance, always pull the plug from the mains socket; do not pull on the cable.
- Never perform any cleaning or maintenance work without having disconnected the appliance from the electricity mains.
- If the appliance breaks down, under no circumstances should you attempt to repair the appliance yourself. Repairs carried out by inexperienced persons may cause injury or further malfunctioning of the appliance. Contact Assistance.
- Do not rest heavy objects on the open oven door.
- The internal surfaces of the compartment (where present) may become hot.
- The glass ceramic hob is resistant to mechanical shocks, but it may crack (or even break) if hit with a sharp object such as

a tool. If this happens, disconnect the appliance from the electricity mains immediately and contact a Service Centre.

- If the surface of the hob is cracked, switch off the appliance to prevent electric shocks from occurring.
- Remember that the temperature of the cooking zones remains relatively high for at least thirty minutes after they have been switched off.
- Keep any object that could melt away from the hob, for example plastic and aluminium objects, or products with a high sugar content. Keep plastic or aluminium objects away from the hob: if you forget them on surfaces that are still hot, they may cause serious damage to the hob.
- The appliance should not be operated by people (including children) with reduced physical, sensory or mental capacities, by inexperienced individuals or by anyone who is not familiar with the product. These individuals should, at the very least, be supervised by someone who assumes responsibility for their safety or receive preliminary instructions relating to the operation of the appliance.
- Do not let children play with the appliance.
- Accessible parts may become hot during use. To avoid burns young children should be kept away.
- Care must be taken when using the bottom storage drawer, as the internal bottom surface of this drawer can get very hot.

Disposal

- When disposing of packaging material: observe local legislation so that the packaging may be reused.
- The European Directive 2002/96/EC relating to Waste Electrical and Electronic Equipment (WEEE) states that household appliances should not be disposed of using the normal solid urban waste cycle. Exhausted appliances should be collected separately in order to optimise the cost of re-using and recycling the materials inside the machine, while preventing potential damage to the atmosphere and to public health. The crossed-out dustbin is marked on all products to remind the owner of their obligations regarding separated waste collection.

Exhausted appliances may be collected by the public waste collection service, taken to suitable collection areas in the area or, if permitted by current national legislation, they may be returned to the dealers as part of an exchange deal for a new equivalent product.

All major manufacturers of household appliances participate in the creation and organisation of systems for the collection and disposal of old and disused appliances.

Respecting and conserving the environment

- You can help to reduce the peak load of the electricity supply network companies by using the oven in the hours between late afternoon and the early hours of the morning.
- Check the door seals regularly and wipe them clean to ensure they are free of debris so that they adhere properly to the door, thus avoiding heat dispersion.

CARE AND MAINTENANCE

Switching the appliance off

Disconnect your appliance from the electricity supply before carrying out any work on it.

Cleaning the appliance

Never use steam cleaners or pressure cleaners on the appliance.

- Clean the glass part of the oven door using a sponge and a non-abrasive cleaning product, then dry thoroughly with a soft cloth. Do not use rough abrasive material or sharp metal scrapers as these could scratch the surface and cause the glass to crack.
- The stainless steel or enamel-coated external parts and the rubber seals may be cleaned using a sponge that has been soaked in lukewarm water and neutral soap. Use specialised products for the removal of stubborn stains. After cleaning, rinse and dry thoroughly. Do not use abrasive powders or corrosive substances.
- The inside of the oven should ideally be cleaned after each use, while it is still lukewarm. Use hot water and detergent, then rinse well and dry with a soft cloth. Do not use abrasive products.
- The accessories can be washed like everyday crockery, and are even dishwasher safe.
- Dirt and grease should be removed from the control panel using a non-abrasive sponge or a soft cloth.
- Stainless steel can be marked by hard water that has been left on the surface for a long time, or by aggressive detergents containing phosphorus. After cleaning, rinse well and dry thoroughly. Any remaining drops of water should also be dried.

Inspecting the oven seals

Check the door seals around the oven regularly. If the seals are damaged, please contact your nearest After-sales Service Centre. We recommend that the oven is not used until the seals have been replaced.

Replacing the oven light bulb

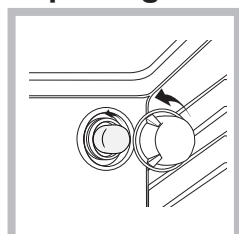

1. After disconnecting the oven from the electricity mains, remove the glass lid covering the lamp socket (see figure).
2. Remove the light bulb and replace it with a similar one: voltage 230 V, wattage 25 W, cap E 14.

3. Replace the lid and reconnect the oven to the electricity supply.

Cleaning the glass ceramic hob

Do not use abrasive or corrosive detergents (for example, products in spray cans for cleaning barbecues and ovens), stain removers, anti-rust products, powder detergents or sponges with abrasive surfaces: these may scratch the surface beyond repair.

- It is usually sufficient simply to wash the hob using a damp sponge and dry it with absorbent kitchen roll.
- If the hob is particularly dirty, rub it with a special glass ceramic cleaning product, then rinse well and dry thoroughly.
- To remove more stubborn dirt, use a suitable scraper (this is not supplied with the appliance). Remove spills as soon as possible, without waiting for the appliance to cool, to avoid residues forming crusty deposits. You can obtain excellent results by using a rustproof steel wire sponge - specifically designed for glass ceramic surfaces - soaked in soapy water.
- If plastic or sugary substances have accidentally been melted on the hob, remove them immediately with the scraper, while the surface is still hot.
- Once it is clean, the hob may be treated with a special protective maintenance product: the invisible film left by this product protects the surface from drips during cooking. This maintenance should be carried out while the appliance is warm (not hot) or cold.
- Always remember to rinse the appliance well with clean water and dry it thoroughly: residues can become encrusted during subsequent cooking processes.

Glass ceramic hob cleaners	Available from
Window scraper Razor blade scrapers	DIY Stores
Replacement blades	DIY Stores, supermarkets, chemists
COLLO luneta HOB BRITE Hob Clean SWISSCLEANER	Boots, Co-op stores, department stores, Regional Electricity Company shops, supermarkets

Assistance

Please have the following information to hand:

- The appliance model (Mod.).
- The serial number (S/N).

This information can be found on the data plate located on the appliance and/or on the packaging.

Removing and fitting the oven door:

1. Open the door
2. Make the hinge clamps of the oven door rotate backwards completely (see photo)

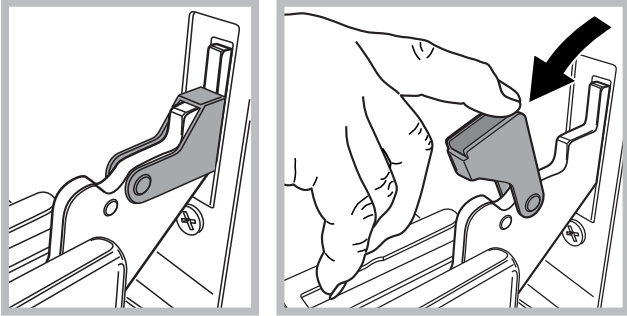

3. Close the door until the clamps stop (the door will remain open for 40° approx.) (see photo)

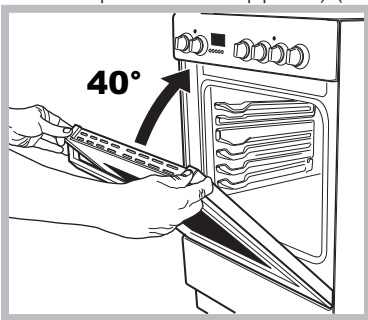

4. Press the two buttons on the upper profile and extract the profile (see photo)

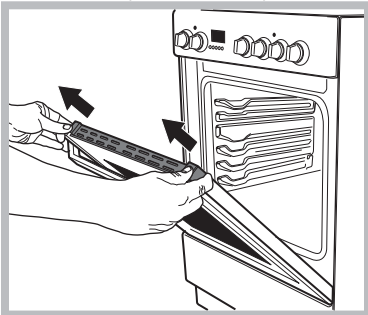

5. Remove the glass sheet and do the cleaning as indicated in chapter: "Care and maintenance".

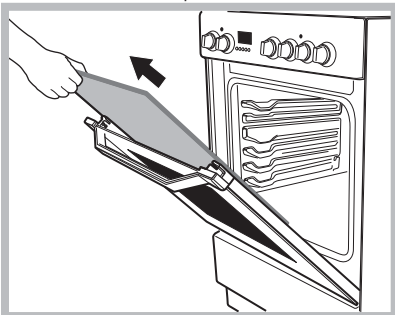

6. Replace the glass.

WARNING! Oven must not be operated with inner door glass removed!

WARNING! When reassembling the inner door glass insert the glass panel correctly so that the text written on the panel is not reversed and can be easily legible.

7. Replace the profile, a click will indicate that the part is positioned correctly.
8. Open the door completely.
9. Close the supports (see photo).

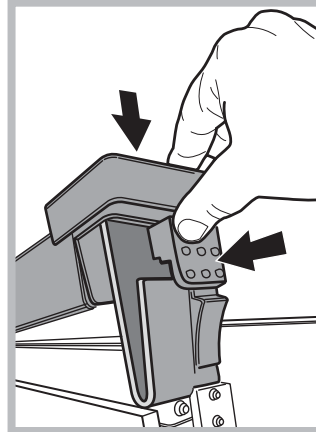

10. Now the door can be completely closed and the oven can be started for normal use.

Steam-Assisted Oven Cleaning

This method of cleaning is recommended especially after cooking very fatty (roasted) meats.

This cleaning process allows to facilitate the removal of dirt of the walls of the oven by the generation of steam that is created inside the oven cavity for easier cleaning.



! Important! Before you start steam -cleaning:

-Remove any food residue and grease from the bottom of the oven.

- Remove any oven accessories (grids and drip pans).

Perform the above operations according to the following procedure:

1. pour 300ml of water into the baking tray in the oven, placing it in the bottom shelf. In the models where the drip pan is not present, use a baking sheet and place it on the grill at the bottom shelf;

2. select the function of the oven: **BOTTOM**   and set the temperature to 100 ° C;

3. keep it in the oven for 15min;

4. turn off the oven;

5. Once cooled the oven, you can open the door to complete the cleaning with water and a damp cloth;

6. eliminate any residual water from the cavity after finishing cleaning

When the steam –cleaning is done, after cooking especially fatty foods, or when grease is difficult to remove, you may need to complete the cleaning with the traditional method, described in the previous paragraph.

! Perform cleaning only in the cold oven!

Whirlpool Management EMEA Srl
Via Carlo Pisacane n.1
20016 Pero (MI), Italy

12/2022 - W11654978
XEROX FABRIANO

www.whirlpool.com

WHIRLPOOL PRIORITY SERVICE

If you are not completely satisfied with your appliance
or require service call:

Australia

Phone: 1300 363 344

New Zealand

Phone: 0800 442 584