

Whirlpool

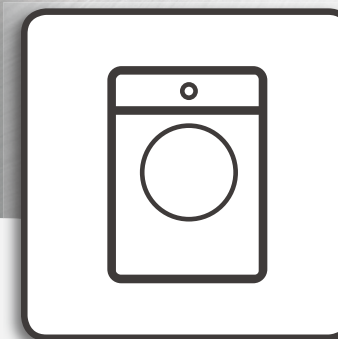

**Health & Safety, Use & Care, Installation Guide**  
**Front Load Washer**  
**Models:**

FWRB8002IW

# CONTENTS



THANK YOU FOR BUYING A WHIRLPOOL PRODUCT.



Read operator's manual

## INSTRUCTION BEFORE WASHING

SAFETY NOTICE -----	2~3
INSTALLATION INSTRUCTIONS -----	4~6
SPECIFICATION SHEET -----	7
NAME OF PARTS -----	8

## OPERATION INSTRUCTION

LOCK AND UNLOCK METHOD -----	9
DOOR -----	9
INTRODUCTION TO DETERGENT DISPENSER -----	10
INTRODUCTION TO CONTROL PANEL -----	11~12
ACCESSORIES -----	13
PROGRAMME INTRODUCTION -----	13~15
VARIOUS FUNCTIONS -----	16
HINTS AND TIPS -----	17
INDICATORS -----	17

## CLEAN AND MAINTENANCE

CLEAN AND MAINTENANCE -----	18~19
NON-FAILURE CONDITION -----	20
TROUBLESHOOTING GUIDE -----	21
AFTER-SALES SERVICE -----	22

# SAFETY NOTICE (be sure to observe)

Before using the appliance, read these safety instructions. Keep them nearby for future reference. These instructions and the appliance itself provide important safety warnings, to be observed at all times. The manufacturer declines any liability for failure to observe these safety instructions, for inappropriate use of the appliance or incorrect setting of controls.

⚠ Very young children (0-3 years) should be kept away from the appliance. Young children (3-8 years) should be kept away from the appliance unless continuously supervised. Children from 8 years old and above and persons with reduced physical, sensory or mental capabilities or lack of experience and knowledge can use this appliance only if they are supervised or have been given instructions on safe use and understand the hazards involved. Children must not play with the appliance. Cleaning and user maintenance must not be carried out by children without supervision. Never open the door forcibly or use it as a step.

⚠ Keep hands and feet away from the bottom of appliance when it is in motion.

### PERMITTED USE

⚠ CAUTION: The appliance is not intended to be operated by means of an external switching device, such as a timer, or separate remote controlled system.

⚠ This appliance is intended to be used in household and similar applications such as: staff kitchen areas in shops, offices and other working environments; farm houses; by clients in hotels, motels, bed & breakfast and other residential environments.

⚠ Do not load the machine above the maximum capacity (kg of dry cloth) indicated in the programme table.

⚠ This appliance is not for professional use. Do not use the appliance outdoors.

⚠ Do not use any solvents (e.g. turpentine, benzene), detergents containing solvents, scouring powder, glass or general purpose cleaners, or flammable fluids; do not machine wash fabrics that have been treated with solvents or spinammable liquids.

⚠ Do not wash, rinse and spin waterproof fabric or clothings eg. sleeping bag, raincoat etc.

⚠ The glass door becomes hot in the process of high temperature washing. Do not touch the door. Wait till temperature drops to a safe level and the door will unlock automatically.

⚠ Keep all packing materials (eg. plastic bag, foam etc) away from children.

⚠ Do not stand or put weight on the top of the appliance.

⚠ Please turn off water supply when appliance is not in use.

### INSTALLATION

⚠ The appliance must be handled and installed by two or more persons - risk of injury. Use protective gloves to unpack and install - risk of cuts.

If you want to stack a dryer on top of your washing machine, first contact our After-Sales Service or your specialist dealer to verify whether this is possible.

This is only possible if the dryer is attached to the washing machine by means of appropriate stacking kit available through our After-Sales Service or your specialist dealer.

⚠ Move the appliance without lifting it by the worktop or top lid.

⚠ Installation, including water supply (if any) and electrical connections and repairs must be carried out by a qualified technician. Do not repair or replace any part of the appliance unless specifically stated in the user manual. Keep children away from the installation site. After unpacking the appliance, make sure that it has not been damaged during transport. In the event of problems, contact the dealer or your nearest After-sales Service.

Once installed, packaging waste (plastic, styrofoam parts etc.) must be stored out of reach of children - risk of suffocation. The appliance must be disconnected from the power supply before any installation operation - risk of electric shock. During installation, make sure the appliance does not damage the power cable - risk of fire or electric shock. Only activate the appliance when the installation has been completed.

⚠ Do not install your appliance where it may be exposed to extreme conditions, such as: poor ventilation, temperatures below 5°C or above 35°C.

⚠ When installing the appliance make sure that the four feet are stable and resting on the floor, adjusting them as required, and check that the appliance is perfectly to level using a spirit level.

⚠ If the appliance is being installed on wood or "floating" floors (certain parquet and laminate materials), secure a 60 x 60 x 3 cm (at least) sheet of plywood to the floor then place the appliance on top of this.

⚠ Water supply hose should be tightly screwed to the appliance.

⚠ Connect the water inlet hose(s) to the water supply in accordance with the regulations of your local water company.

⚠ For cold fill only models: do not connect to the hot water supply.

⚠ For models with hot fill: the hot water inlet temperature must not exceed 60°C.

⚠ The washing machine is fitted with transport bolts to prevent any possible damage to the interior during transport. Before using the machine, it is imperative that the transport bolts are removed. After their removal, cover the openings with the 4 enclosed plastic caps.

⚠ After installation of the device, wait a few hours before starting it so that it acclimates to the environmental conditions of the room.

⚠ Make sure that the ventilation openings in the base of your washing machine (if available on your model) are not obstructed by a carpet or other material.

⚠ Use only new hoses to connect the appliance to the water supply. The old hose-sets should not be reused.

⚠ The supply water pressure must be in the 0.03-1 MPa range.

### ELECTRICAL WARNINGS

⚠ Appliance equipped with electrical wire with Bi-electrode grounding socket. Creepage protector should be used, if possible.

⚠ Do use single socket with Voltage and Current that match the marked specifications. Avoid sharing same socket with other appliance(s) to prevent overloading.

⚠ Thoroughly wipe power plug when dirt is adhering to the prong(s) or around the base of the prongs.

⚠ Do not pull the wire from the socket when unplugging the appliance.

⚠ Do unplug appliance when not in use for a long period of time.

⚠ It must be possible to disconnect the appliance from the power supply by unplugging it if plug is accessible, or by a multi-pole switch installed upstream of the socket in accordance with the wiring rules and the appliance must be earthed in conformity with national electrical safety standards.

⚠ Do not use extension leads, multiple sockets or adapters. The electrical components must not be accessible to the user after installation. Do not use the appliance when you are wet or barefoot. Do not operate this appliance if it has a damaged power cable or plug, if it is not working properly, or if it has been damaged or dropped.

⚠ If the supply cord is damaged, it must be replaced with an identical one by the manufacturer, its service agent or similarly qualified persons in order to avoid a hazard - risk of electric shock.

### CLEANING AND MAINTENANCE

⚠ WARNING: Ensure that the appliance is switched off and disconnected from the power supply before performing any maintenance operation; never use steam cleaning equipment - risk of electric shock.

⚠ No direct contact with water on the appliance during maintenance and repair. May cause short circuit and electric shock.

## ⚠ WARNINGS

### DISPOSAL OF PACKAGING MATERIALS

The packaging material is 100% recyclable and is marked with the recycle symbol ♻.

The various parts of the packaging must therefore be disposed of responsibly and in full compliance with local authority regulations governing waste disposal.

### DISPOSAL OF HOUSEHOLD APPLIANCES

This appliance is manufactured with recyclable or reusable materials. Dispose of it in accordance with local waste disposal regulations. For further information on the treatment, recovery and recycling of household electrical appliances, contact your local authority, the collection service for household waste or the store where you purchased the appliance. By ensuring this product is disposed of correctly, you will help prevent negative consequences for the environment and human health.

The symbol  on the product or on the accompanying documentation indicates that it should not be treated as domestic waste but must be taken to an appropriate collection center for the recycling of electrical and electronic equipment.

## INSTALLATION INSTRUCTIONS

### INSTALLATION INSTRUCTIONS

#### Transport

Transport must be handled by two persons. Two persons should respectively stand on two sides of the washing machine and hold with both hands to transport the washing machine.

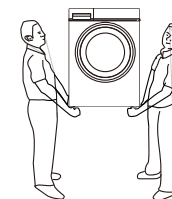

#### Placing the washing machine correctly

The washing machine must be installed on firm, flat and slip-proof ground. Do not place the washing machine on carpeted or wood covered floor. It is forbidden to place the washing machine on a ground platform and rack. The washing machine must keep a minimum distance of 10 cm away from the wall or the hard reflector on three sides.

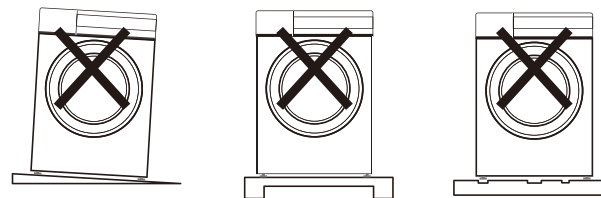

1. On sloping ground 2. On ground platform and rack 3. On uneven ground

#### Removing transport bolts and base protector

To protect the washing machine during transport, the internal structure of the washing machine is fastened with four transport bolts. All the transport bolts should be removed before use. (If the bolts are not removed, the washing machine will vibrate vigorously, generate loud noises and function improperly during spinning.)

1. Loosen the transport bolts (four pieces) with a wrench.
  2. Shake the bolts left and right to pull them out.
  3. Align the bolt covers with the original bolt holes and press until they fit.
- Please keep the transport bolts safe. They are necessary to make a move.
  - Do remove the base protector before use, as shown in the figure, or the washing machine will function improperly.

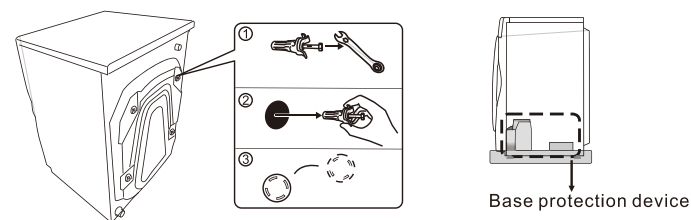

# INSTALLATION INSTRUCTIONS

## Level adjustment

If installed on an uneven place, the washing machine will generate abnormal noises or vibrations or function abnormally when in use.

The feet of the washing machine (the four feet are all adjustable) can be adjusted by the following method:

1. Loosen clockwise the locking nuts of the washing machine feet with the wrench and rotate the feet to adjust the height so as to make the washing machine level.
2. When allowed by conditions, use a level meter to check the adjusted state of the washing machine and make calibration when necessary.

Note: all four feet must reliably touch the ground and stand on the ground firmly.

3. Tighten the locking nuts counterclockwise with the wrench to lock the nuts to the bottom of the case.

4. After adjustment, press the diagonal corners of the top cover of the washing machine by a proper force with two hands to confirm that the washing machine is stable.

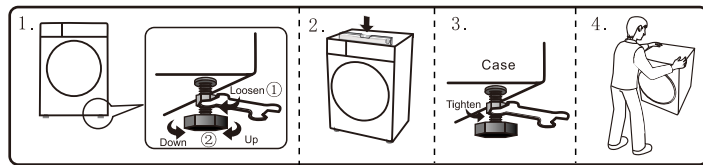

# INSTALLATION INSTRUCTIONS

## Connecting the Supply hose

1. Check that sealing washers are firmly seated.
2. Attach the curved end of the hose to the inlet valve of the washing machine, tighten the coupling nuts securely by hand.
3. Attach straight end of the hose to the tap. Tighten the coupling nuts securely by hand.
4. Turn on the taps and check for leaks. Tighten the coupling nuts firmly if there is any leakage. If water pressure is strong, close the water tap completely then open it slightly.

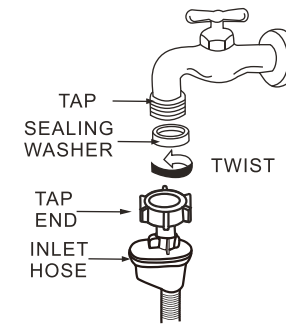

### CAUTION:

- Do not use water which is hotter than 60°C.
- If your faucet is not suitable, please consult your dealer.

## Installing Water Supply Hose to the Washer

Turn the nut clockwise till the nut is tight while holding the hose.

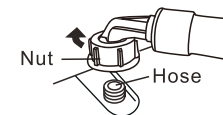

Turn the nut counterclockwise after turning the faucet off if you want to detach the water inlet hose.

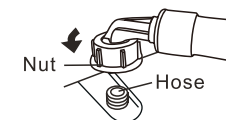



# INSTALLATION INSTRUCTIONS

## CONNECTION OF DRAIN HOSE

1. When washing machine not in use, put drain hose at back of washing machine.(as pic 1 shows)
2. When washing machine in use, put drain hose into drainage pond (as pic 2 shows); you can also put end of drain hose into sewer, leaving space between end of drain hose and sewer elbow to avoid difficulty in draining water out of washing machine.
3. Clean filter in pump periodically to keep washing machine working normally.

**Note:** Do not take off drain hose to avoid drainage problems.

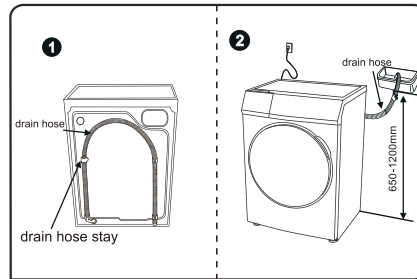

# NAME OF PARTS

## ATTENTION

- We suggest the user to run the Drum clean program before the first wash.
- Don't forget to close the water tap and take down the power plug to avoid any flood and fire disaster.

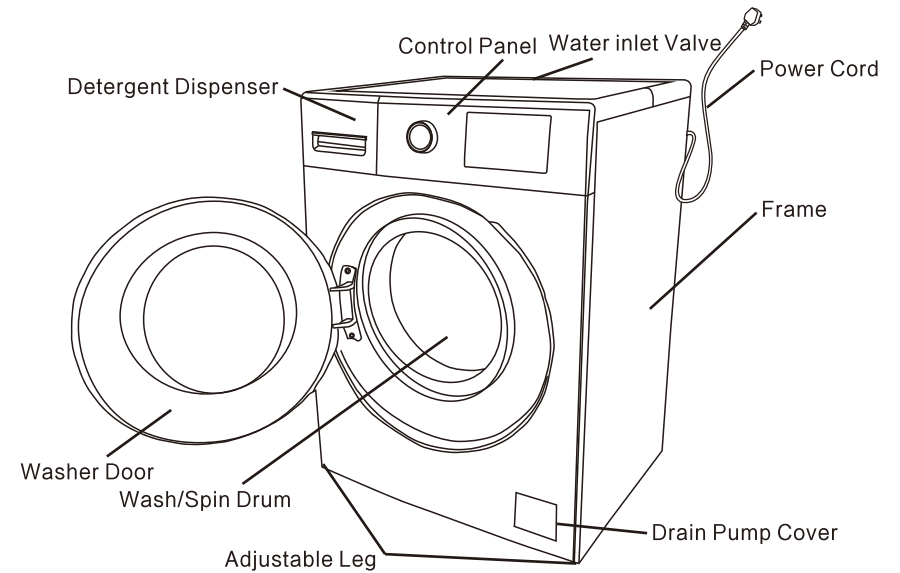

## Specification Sheet

Model	FWRB8002IW
Rated wash capacity	8.0kg
Rated spin capacity	8.0kg
Max current	10A
Rated voltage	220-240V/ 50Hz
Rated heating power	1700W
Rated power	1800W
Water pressure	0.03~1.0MPa
Product dimension	600x580x850
Weight	66kg
Washing Noise	62 dBA
Spinning Noise	79 dBA

## LOCK AND UNLOCK METHOD

### DOOR LOCK

When the machine is working, the door locks automatically. It can't be opened.

### UNLOCK

When the machine is working, press the "Pause Start" button.

The door can be unlocked after inner tub stops spinning.

- If power plug is removed directly or if there is a power cut when the machine is running, the door can't be unlocked automatically.
- If door is opened when the machine is in operation, the foam may spillover. Clean with towel thoroughly.
- The user can't open the door when the machine is running with a high working temperature.
- The user can't open the door when the water temperature is high.

## DOOR

To open the door, pull the handle.

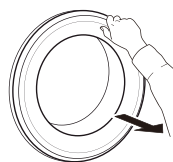

To close the door, hold the handle and push so that you can hear it click shut.



## INTRODUCTION TO EACH COMPARTMENT OF DETERGENT DISPENSER

### WASHING POWDER ● DETERGENT

- This compartment is for filling up with powder or liquid detergent.
- If powder detergent is being used, please mix with a small amount of water to dissolve the detergent before placing into compartment.

### SOFTENER

- Please input the softener before washing. It will be injected automatically before last rinse. If using the concentrated softener, please input it after dilution with water accordingly.

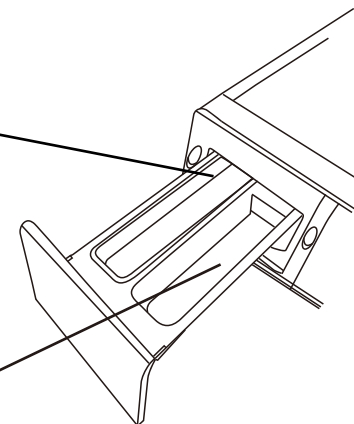

- Please use the specified detergent for front loading washing machine.
- Please don't use superfluous detergent. Otherwise it will cause more foam and influence the rinse performance or cause malfunction.
- Please refer to user guide for proper use of detergent and apply according to the clothes type, color, water temperature and soil level.
- Using moderate detergent can have better washing performance and protect the environment.
- Please don't use excess washing powder to prevent remnants on door gasket at end of wash cycle.

## INTRODUCTION TO THE CONTROL PANEL

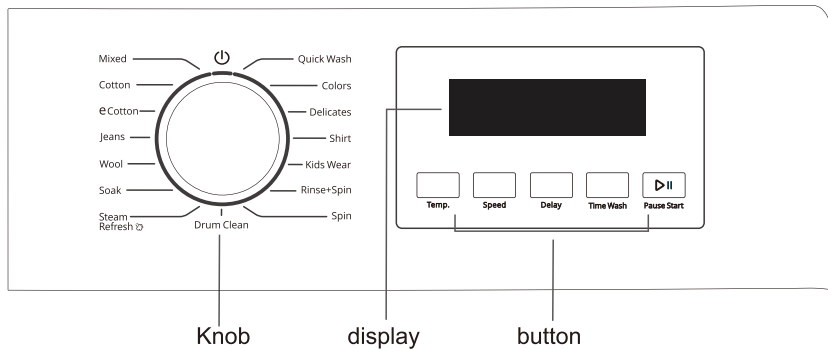

### ■ Pause Start

- Press button once to start and press again to stop.



### ■ Power button

- This is for turning on / off the machine.  
When the program finishes, machine switches off automatically.



### ■ Programme choice

- Choose a suitable programme according to clothes type and dirt level.

### ■ Display window introduction

- When power is turned on, it will display the spin speed and other functions.
- When machine is in operation, it will display the time remaining.
- When machine breakdowns, it will display the error code.

### ■ Temp button

- Set the washing temperature according to the clothes type.
- The temperature setting range is different among programmes. Some of them have range limitations.

## INTRODUCTION TO THE CONTROL PANEL

### ■ Speed button

- Set the spin speed according to user's requirement.
- Some programmes have limitations on setting the spin speed.

### ■ Delay button

- This option makes it possible for users to define the end of the washing time for up to 24 hours.





### ■ Time Wash button

- Users can choose between various washing time.
- Press Time wash button and refer to Programme Chart for selectable timing.

## PROGRAMME INTRODUCTION

Programme	Temperatures		Selectable Spin Speed (rpm)		Max Wash Load (kg)	Programme Time *
	Default	Range	Default	Range		
Mixed	30°C	☼ - 60°C	800	0-1200	6	**
Cotton	30°C	☼ - 90°C	800	0-1400	7.5	
e Cotton	40°C	-	1200	-	8	
Jeans	30°C	☼ - 40°C	800	0-1200	5	
Wool	☼	☼ - 40°C	600	0-800	2	
Soak	30°C	☼ - 60°C	800	0-1200	6	
Steam Refresh	-	-	-	-	1	
Quick wash	☼	☼ - 30°C	800	0-1400	1	
Colors	15°C	-	600	0-800	3	
Delicates	☼	☼ - 40°C	400	0-600	3	
Shirt	30°C	☼ - 60°C	800	0-1000	3	
Kids wear	30°C	☼ - 90°C	800	0-1000	4	
Rinse + spin	-	-	800	0-1400	8	
Spin	-	-	800	0-1400	8	
Drum clean	90°C	-	800	-	-	

## ACCESSORIES

Instruction manual	Water Supply Hose	Lid (4Piece)	Spanner	Product Warranty Certificate
				

## PROGRAMME INTRODUCTION

Time wash	Delay Start	Description of Programme
✓	✓	For washing lightly to normally soiled garments in cotton, linen, synthetic fibres and mixed fibres.
✓	✓	Normally to heavily soiled and robust cottons.
-	✓	For washing normally soiled cotton garments. This is the standard cotton programme and the most efficient in terms of water and energy consumption.
✓	✓	Suitable for washing denim clothes.
✓	✓	Wool garments can be washed using this programme. For best results, use special detergent and do not exceed maximum kg.
✓	✓	The process of soaking first and then cleaning, suitable for washing synthetic fiber.
✓	✓	This programme refreshes garments by removing bad odours and relaxing the fibres. Insert dry items only (that are not dirty) and select programme "Steam Refresh". Garments will be a little damp at the end of the cycle and can be worn after a few minutes. The "Steam Refresh" programme makes ironing easier. ! Not recommended for wool or silk garments. ! Do not add softeners or detergents.
✓	✓	For quick washing of small load or lightly soiled garments.
✓	✓	Preserve the color vibrancy of garments.
✓	✓	Suitable for washing silk and chiffon fabrics.
✓	✓	Suitable for washing shirts.
✓	✓	Suitable for washing children's clothing.
✓	✓	For clothes that only need to be rinsed and spinned.
✓	✓	Spins the load then empties the water.
-	✓	For drum cleaning only, using high temperature to sterilize the drum to effectively remove dirt and bacteria.

### Test wash cycle in compliance with regulation and AS/NZS 2040.1 and AS/NZS 2040.2:

set programme e Cotton with a temperature of 40°C at 1200rpm.

\* This data may differ in your home due to changing conditions in inlet water temperature, water pressure etc. Approximate programme duration values refer to the default setting of the programmes, without options.

\*\* The duration of the programme is shown on the display.

## PROGRAMME INTRODUCTION

### User instruction for the normal clothes

#### Method

1. Preparation
  - Put the clothes in and close the door.
  - Put the detergent or washing powder into the detergent box.
  - Turn on the water tap, connect the drain-pipe, plug in the power supply.
2. Switch on the power.
3. Choose the suitable programme.
4. Choose the suitable button.
5. Press the "Pause Start" button.
6. When washing ends, the buzzer will sound.

### Instruction to Wool programme

#### Method

- Turn on machine and choose the wool programme.

#### Attention

- Please confirm the washing mark on the clothes before washing.
- When washing ends, please take the clothes out immediately for airing in order to avoid clothes deformation.
- The temperature can't be more than 40 degrees to avoid spoiling the fabrics.
- Using the wool detergent can improve the washing performance.
- Make Separate washing for light colour clothes and dark colour clothes.

## VARIOUS FUNCTIONS

### Introduction to Delay wash

#### Method

- Turn on machine and choose the suitable programme according to user's requirement. Press the delay button to determine the finishing time. Press the start/stop button to start-up the delay wash function. (Delay time has one hour interval and goes to a maximum of 24 hours.)

#### Attention

- If user need to amend the time, please press power button and reset.
- After selection, user can still cancel it by pressing on power button.
- Once delay wash has been confirmed, press the delay button. The set time will be displayed for 5 seconds.
- Delay wash duration differs based on water pressure, laundry load, clothes type, water temperature.

### Cancel the buzzer

There is no buzzer when cycle ends if the buzzer function is canceled.

#### Set/Cancel method

Turn on machine and press "Start/Stop" button till buzzer sounds. When button is released, the buzzer sound will be deactivated. To reactive, repeat steps.

### CHILD PROTECTION FUNCTION

If machine door is opened before programme starts the machine will activate the child protection function automatically. The door will be locked and motor will be running for a while. Next, the door will be unlocked for a while till working again. If the door is opened during the waiting time, the machine will stop automatically.

### CHILD LOCK FUNCTION

User can activate the child lock function in order to prevent children from playing with machine during operation. Both the door and programme buttons will be locked automatically. Door will be unlocked once function has been deactivated.

#### Set/Cancel method

Turn on machine and press "temperature" button for 3 seconds till the buzzer sounds. The child lock function is activated. Repeat steps to deactivate.







## HINTS AND TIPS

### RULES FOR SEPARATING LAUNDRY

- Fabric type / indications on label (cotton, mixed fibres, synthetic, wool, handwash items)
- Colour (separate coloured garments from whites, wash new coloured items separately)
- Size (wash items of different sizes in the same load to improve washing efficacy and weight distribution in the drum)
- Delicates (place small items – such as nylon stockings – and garments with clasps – such as braziers – in a laundry bag or in a pillow case with a zip).

### WASH SYMBOLS ON GARMENT LABELS

The value given in the tub symbol is the maximum temperature possible for washing the garment.

-  Normal mechanical action
-  Reduced mechanical action
-  Much reduced mechanical action
-  Hand wash only
-  Do not wash





### CLEAN THE WATER FILTER REGULARLY

- This is needed to prevent the filter from blocking and preventing the water from draining correctly.

### SAVING ENERGY AND PROTECTING THE ENVIRONMENT

- Keeping within the load limits indicated in the “PROGRAMME CHART” will optimise energy, water and detergent consumption and reduce washing times.
- Do not exceed the detergent quantities recommended by the detergent manufacturer.
- Save energy by using a 60 °C instead of a 90 °C wash programme, or by using a 40 °C instead of a 60 °C wash programme. We recommend using “Eco Cotton” programme, which is longer, but uses less energy.
- To save energy and time when washing, select highest spin speed available for the programme to reduce the residual water remaining in the garments at the end of the wash cycle.
- Pretreat any stains with an appropriate stain remover, or else dampen any dried-on stains with water prior to washing, as this will reduce the need to use a high temperature wash programme.
- Wash&dry 60' programme applicable to quick washing and drying of a few clothes with few stains.

## INDICATORS

	Child Lock	This indicator will light up: Child lock function activated, all buttons (except for power button) locked.
	Delay end	This indicator will light up: Delay end function activated.
	Door lock	This indicator will light up: 1. Machine is running a programme. 2. High Temperature in drum. 3. High Water level.
	Add clothes	This indicator will light up: Door can be opened to add or remove clothes.

## CLEANING AND MAINTENANCE

**For any cleaning and maintenance, switch off and unplug the washing machine. Do not use flammable fluids to clean the washing machine.**

### CLEANING THE OUTSIDE OF THE WASHING MACHINE

Use a soft damp cloth to clean the outer parts of the washing machine.

Do not use glass or general purpose cleaners, scouring powder or similar to clean the control panel – these substances might damage the printing.

### CHECKING THE WATER SUPPLY HOSE

Check the inlet hose regularly for brittleness and cracks. If damaged, replace it by a new hose available through our After-Sales Service or your specialist dealer. Depending on the hose type:

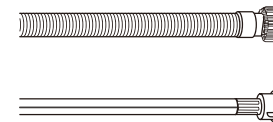

If the inlet hose has a transparent coating, periodically check if the colour intensifies locally. If yes, the hose may have a leak and should be replaced.

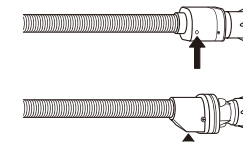

For water stop hoses: check the small safety valve inspection window (see arrow). If it is red, the water stop function was triggered, and the hose must be replaced by a new one. For unscrewing this hose, press the release button (if available) while unscrewing the hose.

## CLEANING AND MAINTENANCE

- Proper cleaning and maintenance can prolong the lifespan of machine.
- Please unplug the power supply during maintenance.

### MACHINE BODY

- Please use a soft cloth to clean the body after washing every time. If there is too much dirt, please apply some detergent or soap water on the cloth to clean the body.
- Please don't use water to flush the machine directly.
- Dirty powder, diluent, petrol and alcohol are forbidden for use to clean the machine.

### DOOR GASKET

Please use cloth to clean the gasket after washing every time. If there are brooch or other sundries, please ensure to remove.

### DETERGENT DISPENSER CLEANING

Please clean the detergent box periodically. Remove the box and clean it with water.

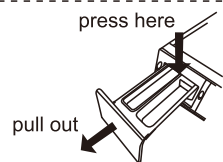

### INLET VALVE CLEANING (RECOMMENDED ONCE EVERY SIX MONTHS)

1. Take out the inlet pipe
2. Take out the lint filter screen
3. Use a toothbrush to clean the lint filter screen and then assemble it again
4. Connect the inlet pipe after cleaning.

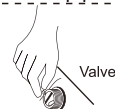

### DRUM CLEANING (RECOMMENDED MONTHLY)

There may be dirt residue resting in the tub after prolonged usage.  
(Attention: please don't put in clothes and detergent when using this program.)

### CLEANING PUMP FILTER (RECOMMENDED MONTHLY)

1. Insert coin into the groove of pump and press it. The filter cover can be opened.  
Attention: If there is hot water in the machine, please wait for water to cool down before opening the filter.
2. Remove the filter in an anticlockwise direction.
3. Wash the filter with water.
4. Assemble the filter into the pump in a clockwise direction.

Attention: 1. The filter should be assembled tightly in order to avoid water leakage.  
2. Please don't clean the filter when the machine is working.

The groove of pump cover

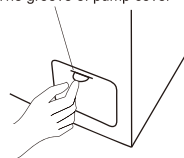

## NON-FAILURE CONDITION

Condition	Possible Reason
Door can't be opened	<ul style="list-style-type: none"> <li>● Water temperature is too high or power cut.</li> <li>● Child lock activated.</li> <li>● The clothes are clamped between door and gasket.</li> </ul>
Peculiar smell	<ul style="list-style-type: none"> <li>● Due to rubber components, the rubber smell lingers at the beginning.</li> </ul>
No water	<ul style="list-style-type: none"> <li>● Ensure that tap is turned on.</li> <li>● Ensure filter is not blocked.</li> </ul>
Water is being drained during wash cycle	<ul style="list-style-type: none"> <li>● Too much bubbly detergent.</li> </ul>
Residual time change	<ul style="list-style-type: none"> <li>● Washing machine will automatically fill water to ensure clothes are evenly distributed.</li> <li>● The time remaining is calculated based on 15L/min inflow. So according to different water pressure, time will be prolonged or shortened.</li> <li>● Washing machine will prolong washing time if clothes are not evenly distributed.</li> </ul>
Abnormal sound during spinning	<ul style="list-style-type: none"> <li>● Is power line connect to cabinet?</li> <li>● Is the carriage bolts have been removed?</li> <li>● Is there a hairpin, coins or other foreign objects stuck in the drum?</li> </ul>
Failure to work after power failure	<ul style="list-style-type: none"> <li>● If machine fails to operate after power failure, press "power turn on/ off" to recover and reset program.</li> </ul>
Emergency door opening	<ul style="list-style-type: none"> <li>● During power failure or appliance failure, the door remains locked. To remove the clothes, unplug the power cord and wait for the inner drum to stop before pulling down the emergency rope located on bottom right corner of cabinet. Observe a slight noise before you can open the door. Confirm that water level is below the bucket and water temperature is below 60°C in advance.</li> </ul>

## TROUBLESHOOTING GUIDE

Error Code	Reason	Inspection factors	solution
No display	Out of operation	<ul style="list-style-type: none"> <li>• whether the outlet have electricity</li> <li>• whether the outlet is plugged in</li> <li>• power cut or not</li> <li>• leakage protector switch off or not</li> </ul>	
E11	No water	<ul style="list-style-type: none"> <li>• Whether tap is turned on or off</li> <li>• Whether filter has any blockage</li> <li>• Whether water has stopped flowing or not</li> </ul>	Press the "Pause Start" button
E12	Draining failure	<ul style="list-style-type: none"> <li>• Whether drain pipe is in the right place</li> <li>• Whether drain height is too high or low</li> <li>• Whether there is blockage in drain-pipe</li> </ul>	Press the "Pause Start" button
H	Door can't be opened	<ul style="list-style-type: none"> <li>• Make sure water temperature has cooled down.</li> <li>• Suspension of washing</li> </ul>	Door unlocks automatically once temperature has dropped to safe range
U3	Spinning function doesn't work	<ul style="list-style-type: none"> <li>• Ensure washer is placed stably.</li> <li>• Avoid overloading with too much clothes.</li> <li>• Reduce load.</li> <li>• Avoid rolling blanket up into machine.</li> </ul>	Add or delete 2 pieces of clothes and press the "Pause Start"
U4	Door not closed		Close the door, wait for "locked" light to be activated before pressing "Pause Start" to continue
Other code	Alarm		Press "Pause Start" to resume operation. If problem persists, contact the service center.

## AFTER-SALES SERVICE

### BEFORE CALLING THE AFTER-SALES SERVICE

1. See if you can solve the problem by yourself with the help of the suggestions given in the **TROUBLESHOOTING**
2. Switch the appliance off and back on again to see if the fault persists.

### IF AFTER THE ABOVE CHECKS THE FAULT STILL OCCURS, GET IN TOUCH WITH THE NEAREST AFTER-SALES SERVICE

When contacting our Client After-sales service, always specify:

- a brief description of the fault;
- the type and exact model of the appliance;
- your full address;
- your telephone number.

If any repairs are required, please contact an authorised after-sales service (to guarantee that original spare parts will be used and repairs carried out correctly).

